

Iridium 9555 Satellite Phone User Manual





Iridium 9555 Satellite Phone

User Manual



web: www.iridium.com

email: info@iridium.com

toll free: +1.866.947.4348

phone: +1.480.752.5155

address:

Iridium Satellite LLC

1800 S. Price Road

Chandler, AZ 85286, USA



Prior to using the Iridium 9555 Satellite Phone read and understand this User Manual including the safety warnings and information. Failure to do so could result in serious injury or death.

© Copyright 2018 Iridium Satellite LLC. All rights reserved. Iridium and the Iridium Logo are registered trademarks of Iridium Satellite LLC and its affiliates. All other trademarks, service marks and logos are the property of their respective holders, which have not endorsed, sponsored or otherwise affiliated with Iridium. Information is subject to change without notice. (Version H2UG1801).

Legal Notices

This User Manual provides user information and is provided “as is.” Iridium and its affiliated companies, directors, officers, employees, agents, trustees or consultants (“Iridium”) assume no responsibility for any typographical, technical, content or other inaccuracies in this User Manual. Iridium reserves the right to revise this User Manual or withdraw it at any time without prior notice. You can find the current version of this Iridium 9555 Satellite Phone User Manual at <https://www.iridium.com/products/iridium-9555/>



Prior to using the Iridium 9555 Satellite Phone, read and understand this User Manual including the safety warnings and information. Failure to do so could result in serious injury or death.

IRIDIUM MAKES NO REPRESENTATIONS, GUARANTEES, CONDITIONS OR WARRANTIES, EITHER EXPRESS OR IMPLIED, INCLUDING WITHOUT LIMITATION, ANY IMPLIED REPRESENTATIONS, GUARANTEES, CONDITIONS OR WARRANTIES OF MERCHANTABILITY AND FITNESS FOR A PARTICULAR PURPOSE, NON-INFRINGEMENT, SATISFACTORY QUALITY, NON-INTERFERENCE, ACCURACY OF INFORMATIONAL CONTENT, OR ARISING FROM A COURSE OF DEALING, LAW, USAGE, OR TRADE PRACTICE, USE, OR RELATED TO THE PERFORMANCE OR NONPERFORMANCE OF ANY PRODUCTS, ACCESSORIES, FACILITIES, SERVICES OR USER INFORMATION, EXCEPT AS EXPRESSLY STATED IN THE LIMITED WARRANTY. ANY OTHER STANDARDS OF PERFORMANCE, GUARANTEES, CONDITIONS AND WARRANTIES ARE HEREBY EXPRESSLY EXCLUDED AND DISCLAIMED TO THE FULLEST EXTENT PERMITTED BY LAW. THIS DISCLAIMER AND EXCLUSION SHALL APPLY EVEN IF THE EXPRESS LIMITED WARRANTY CONTAINED IN THIS USER MANUAL FAILS OF ITS ESSENTIAL PURPOSE. FURTHER, THIS LIMITED WARRANTY COVERS THE IRIDIUM 9555 SATELLITE PHONE (INCLUDING HARDWARE, SOFTWARE AND/OR FIRMWARE, BUT EXCLUDING LEATHER CASE) AND ACCESSORIES ONLY, AND NO WARRANTY IS MADE AS TO USER INFORMATION AND/ OR COVERAGE, AVAILABILITY OR GRADE OF SERVICE PROVIDED BY IRIDIUM SEPARATELY FOR IRIDIUM SATELLITE SERVICES.

IN NO EVENT SHALL IRIDIUM BE LIABLE, WHETHER IN CONTRACT OR TORT OR ANY OTHER LEGAL THEORY, INCLUDING WITHOUT LIMITATION STRICT LIABILITY, GROSS NEGLIGENCE OR NEGLIGENCE, FOR ANY DAMAGES IN EXCESS OF THE PURCHASE PRICE OF THE IRIDIUM 9555 SATELLITE PHONE (INCLUDING HARDWARE, SOFTWARE AND/OR FIRMWARE) AND/OR ACCESSORIES AND/OR THE COST OF IRIDIUM SATELLITE SERVICES PROVIDED. NOR SHALL IRIDIUM BE LIABLE FOR ANY DIRECT, INDIRECT, INCIDENTAL, SPECIAL, CONSEQUENTIAL, OR PUNITIVE DAMAGES OF ANY KIND, OR LOSS OF REVENUE OR PROFITS, LOSS OF BUSINESS, LOSS OF PRIVACY, LOSS OF USE, LOSS OF TIME OR INCONVENIENCE, LOSS OF INFORMATION OR DATA, SOFTWARE OR APPLICATIONS OR OTHER FINANCIAL LOSS CAUSED BY THE IRIDIUM 9555 SATELLITE PHONE (INCLUDING HARDWARE, SOFTWARE AND/OR FIRMWARE) AND/OR ACCESSORIES AND/OR THE IRIDIUM SATELLITE SERVICES, OR ARISING OUT OF OR IN CONNECTION WITH THE ABILITY OR INABILITY TO USE THE IRIDIUM 9555 SATELLITE PHONE (INCLUDING HARDWARE, SOFTWARE AND/OR FIRMWARE) AND/OR ACCESSORIES AND/OR THE IRIDIUM SATELLITE SERVICES TO THE FULLEST EXTENT THESE DAMAGES MAY BE DISCLAIMED BY LAW AND REGARDLESS OF WHETHER IRIDIUM WAS ADVISED OF THE POSSIBILITIES OF SUCH DAMAGES.

Third Party Information

This User Manual might refer to third party sources of information, hardware or software, products or services and/or third party web sites (“third party information”). Iridium does not control, and is not responsible for, any third party information, including without limitation the content, accuracy, copyright compliance, compatibility, performance, trustworthiness, legality, decency, links, or any other aspect of third party information. The inclusion of such third party information does not imply endorsement by Iridium of the third party information. ANY THIRD PARTY INFORMATION THAT IS PROVIDED WITH IRIDIUM'S FACILITIES, SERVICES, PRODUCTS OR USER INFORMATION IS PROVIDED “AS IS.” IRIDIUM MAKES NO REPRESENTATIONS, GUARANTEES OR WARRANTIES IN RELATION TO THIRD PARTY INFORMATION AND IRIDIUM SHALL NOT BE LIABLE FOR ANY LOSSES, DAMAGES, LIABILITIES, JUDGMENTS, FINES, AMOUNTS PAID IN SETTLEMENT, EXPENSES OR COSTS OF DEFENSE SUSTAINED IN RELATION TO ANY SUCH THIRD PARTY INFORMATION.

Intellectual Property, Trade Secret, Proprietary or Copyrighted Information

To protect Iridium proprietary and confidential information and/or trade secrets, this User Manual may describe some aspects of Iridium technology in generalized terms. Iridium products may include copyrighted Iridium and third party software. Any such copyrighted software contained in Iridium products may not be modified, reverse engineered, distributed or reproduced in any manner to the extent provided by law. The purchase of any Iridium products shall not be deemed to grant either directly or by implication or otherwise, any license under copyrights, patents, or patent applications of Iridium or any third party software provider, except for the normal, nonexclusive, royalty free license to use that arises by operation of law in the sale of a product. Please refer to Chapter 17 of this User Manual for Limited Warranty, Product and Satellite Service Terms and Warranty Support, Conditions of Use and Software License.

Content Copyright

You are exclusively responsible for the use of the User Manual, including proper use of third party copyrighted materials. If you violate these terms you agree to defend, indemnify and hold Iridium harmless with respect to any claims or actions by third parties related to your improper use of copyrighted materials and to pay all costs, damages, fines and other amounts incurred by Iridium, or on its behalf, in the defense of any such claims or actions.

Contents

1: Introduction	1
Related Documents	1
2: Important Safety Information	3
Safety and Warning Icons	3
Exposure to Radio Frequency Signals	4
Specific Absorption Rate Data	4
Batteries	6
Battery Charging	7
Emergency Calling	7
Antenna Care	8
Driving and Operation of Other Motor Vehicles	8
Posted Facilities	9
Potential Explosive Atmospheres	9
Electronic Devices	9
Product Operation	10
Radio Interference	10
Implantable Medical Devices	10
Persons with pacemakers:	11
Hearing Aids	11
Extended Exposure to Loud Noise	11
Other Medical Devices	12
Aircraft	12
Vehicles	12
Vehicles Equipped with an Air Bag	12
Adult Use Only	13
Glass Parts	13
Seizures and Blackouts	13
Repetitive Motion	13
3: Iridium 9555 Satellite Phone Overview	15
Guide Overview	15
Phone Overview	16
Front View	16
Side View	17
Back View	18
Accessories	19
AC Travel Charger and International Plug Kit	19
Headset	20
Auto Accessory Adaptor	20

To install the Antenna Adaptor	21
Auxiliary Antenna Adaptor	21
Indicators	22
Status Indicator LED	22
Display Status Indicators and Icons	22
Main Screen Components	23
Menu Components	23
4: Getting Started	25
Using the SIM Card	25
SIM Card Care	25
Insert the SIM Card	26
Remove the SIM Card	26
Battery Pack Information	27
Remove and Install the Battery Pack	29
To Remove the Battery Pack	29
To Install the Battery Pack	30
Charging the Battery	31
Charge the Battery Pack	31
Checking Battery Charge Level	31
Low Battery Warning	31
Blasting Areas	32
Start-up Procedure	
Power on Message	32
Potential Explosive Atmospheres	33
Phone Operation	34
Normal Operation	34
Extended Exposure to Loud Noise	34
Persons with pacemakers:	35
Adult Use Only	35
Seizures and Blackouts	35
Tips on Efficient Operation	36
Placing a Call	36
Before you place a call:	36
Dial the Number	36
End a Call	39
Re-dial Last Number Called	39
Receiving a Call	39
Before you receive a call:	39
Receiving a call with the Antenna Extended	40
Answering the call with the Antenna Extended	41
Receiving a Call with the Antenna Stowed	42
Muting a Call	44

Speaker Phone.....	44
Speaker Volume.....	44
Ringer Volume.....	45
Unanswered Calls	46
Messages from Missed Calls.....	46
Locking and Unlocking the Keypad.....	47
Unlocking the Keypad.....	48
5: Using Menus and Keys.....	49
Using the Keys.....	49
The Soft Keys	49
The 2-way Navi-key	49
The Keypad.....	50
Using the Menus	50
To Access the Main Menu	50
To Access Main Menu Options	51
To Return to a Menu.....	52
Entering Characters	52
6: Traditional Text Entry	55
Entering Characters	55
Keypad Guide.....	56
Entering Punctuation and Symbols	57
Entering Numbers and Symbols into Text	58
7: Predictive Text Entry.....	61
LetterWise Text mode.....	64
WordWise Text mode.....	66
Digit mode (123)	68
Punctuation mode (#?@).....	68
8: Using the Phonebooks	71
Organizing My Phonebook.....	71
Phone Memory	71
SIM Card Memory	71
Locating My Phonebook.....	71
About the My Phonebook Menu	72
Add a New Entry to My Phonebook.....	73
Locating Entries.....	75
Calling an Entry	76
Using the Short Message Service (SMS) Menu	78
Sending an SMS Message.....	79
Adding an SMS Message.....	80
Edit an Entry in My Phonebook	81

Delete an Entry	83
Viewing Memory Status	85
Adding Notes to a Phonebook Entry	86
Restricted Phonebook.....	87
9: Using the Messages Menu	89
Locating the Messages Menu.....	89
Create and Send a new SMS Message to an Email Address not in your Phonebook	90
Create and Send a new SMS Message to an Email Address in My Phonebook	92
About SMS Messaging	94
Message Notification.....	94
How Messages are Stored.....	94
What Messages Contain	94
Using the Inbox	95
Read a Message	95
Reply to Sender	96
Forward a Received Message	97
Call a Number from a Received Message	100
Delete a Message	100
Using the Drafts Menu	102
Using the Settings Menu.....	105
Enter Service Center Number	105
Set Expiry Period	106
Select Delivery Reports.....	108
10: Using the Voicemail Menu	109
Locating the Voicemail Menu	109
About the Voicemail Menu.....	109
Voicemail Notification.....	110
Check Your Voicemail	110
Store Your Voicemail Number.....	111
One-Touch Access to Voicemail.....	112
11: Using the Data Modem Menu	113
Locating the Data Modem Menu.....	113
12: Using the Call History Menu	115
Locating the Call History Menu	115
About the Call History Menu	115
Using the Call Log Menu	116
View Most Recent Received Calls	116
View Missed Calls	117

View Most Recent Dialed Calls	118
Using the Call Meters Menu	120
Show the Time of Last Call.....	120
Show Total Time for All Calls	121
Reset all Timers	122
Showing the Lifetime Call Timer.....	124
Showing the In-call Display.....	125
Setting Audible Call Timers	127
Set the Single Alert Timer	127
Set the Repetitive Alert.....	129
13: Using the Setup Menu	131
Locating the Setup Menu	131
About the Setup Menu	131
Setting Call Options	132
Setting Volumes and Tones.....	133
Adjust the Ringer Volume	133
Adjust the Speaker Volume.....	135
Adjust the Ring Tone.....	136
Setting the Call Alert Mode.....	138
Setting the Keypad Tone	139
Set the Phone to Ring and /or Vibrate.....	141
Time and Date Settings	142
Select the Time Zone	142
Select the Time Format	144
Select the Date Format	145
Selecting the Display Language.....	146
Setting Backlights.....	148
Setting Contrast	149
Using the Key Setup Menu.....	150
Setup the Convenience Key Function	150
Setup the Right Soft Key Function	151
Set Number Entry Prefix	152
View Phone Information	153
Reset Phone Options to Factory Defaults	154
14: Using the Security Menu	157
Locating the Security Menu.....	157
About the Security Menu.....	158
Locking and Unlocking Your Phone.....	158
Using the GPS Options Menu	159
Enable or Disable the SIM lock.....	159
Using the Change PIN Menu.....	161

Change the Phone PIN Code	161
Change the SIM PIN Code.....	163
Change the SIM Card PIN2 Code	165
Call Barring PIN	167
Problem	169
Solution	169
15: Troubleshooting	169
17: Certification and Compliance Information	173
Export Compliance.....	173
Standards Compliance Information	173
U.S. Federal Communications Commission.....	173
EU Regulatory Conformity.....	173
Canada Regulatory Conformity	173
18: Limited Warranty	175
Including Exclusions, Disclaimers, Limitations of Liability and Conditions of Use;	
Warranty Claim Process and Privacy and Data Security	175
Exclusions	176
Disclaimers	177
Limitations of Liability and Conditions of Use.....	178
Warranty Claim Process	181
Privacy and Data Security.	181
Disclosure to Governmental and Quasi-Governmental Agencies .	181
SOFTWARE LICENSE	182

1: Introduction

Thank you for purchasing the state of the art Iridium 9555 Satellite Phone.

This User Manual contains the procedures for the safe operation of the satellite phone and the available facilities.

Important: Read this entire manual, including the safety information in Chapter 2 before using the Iridium 9555 Satellite Phone.

Related Documents

The following Iridium product documentation is available to help you:

- Iridium 9555 Satellite Phone Specification Sheet
- Iridium 9555 Satellite Phone Quick Start Guide

Refer to www.iridium9555.com for your copies.

2: Important Safety Information





WARNING!



Prior to using the Iridium 9555 Satellite Phone, read and understand this User Manual including the safety warnings and information. Failure to do so could result in serious injury or death.

This User Manual contains important safety warnings and information regarding the proper use and care of the handset. Section 2 of the Iridium 9555 Satellite Phone User Manual contains important information regarding exposure to radio frequency signals, specific absorption rate (SAR) data, proper handling of batteries, and other important safety information. Before using the Iridium 9555 Satellite Phone be sure to read and understand this manual.

Safety and Warning Icons

The following conventions are used in this User Manual.

	Warning! Failure to comply with this warning could result in death or serious injury. Before doing this task, be sure to familiarize yourself with appropriate safety practices, personal protective equipment and have a plan in case of accident.
	Do not let your battery, charger, or satellite phone come in contact with water.
	Risk of explosion.
	High heat source. Burn risk.
	Do not dispose in trash.

	Do not dispose of your battery in a fire.
	Harmful noise.

Exposure to Radio Frequency Signals

Your Iridium 9555 Satellite Phone is a low power radio transmitter and receiver. When it is ON, it receives and sends out radio frequency (RF) signals. Your Iridium 9555 Satellite Phone is designed to comply with local regulatory requirements in your country concerning the exposure of human beings to RF frequency.

International agencies have set standards and recommendations for the protection of public exposure to RF electromagnetic energy.

- International Commission on Non-Ionizing Radiation Protection (ICNIRP)
- Verband Deutscher Elektrotechniker (VDE)
- United States Federal Communications Commission (FCC), Radio Frequency Exposure Guidelines
- National Radiological Protection Board of the United Kingdom
- American National Standards Institute (ANSI) IEEE. C95. 1-1992
- National Council on Radiation Protection and Measurements (NCRP) Report 86
- Department of Health and Welfare Canada. Safety Code 6

The design of your phone complies with these standards when used as described under "Phone Operation" on page 34.

This product is compliant with ISED RSS-102 for RF Exposure.

Refer to "Specific Absorption Rate Data" on pages 4-5.

Specific Absorption Rate Data

This Iridium 9555 Satellite Phone meets international standards for exposure to radio waves.

Your satellite phone is designed and manufactured not to exceed limits for exposure to radio frequency (RF) energy. These limits are part of

comprehensive guidelines and established permitted levels of RF energy for the general population. The guidelines are based on standards that were developed by independent scientific organizations through periodic and thorough evaluation of scientific studies. The guidelines include a substantial safety margin designed to assure the safety of all persons, regardless of age and health.

The exposure standard for mobile phones employs a unit of measurement known as the Specific Absorption Rate, or SAR. Under the guidelines for this model, the SAR limit is 1.6 W/Kg. Tests for SAR were conducted in accordance with the European Committee for Electrotechnical Standardization (CENELEC) and FCC testing procedures using standard operating positions with the phone transmitting at its highest certified power level in all tested frequency bands. Although the SAR is determined at the highest certified power level, the actual SAR of the phone while operating can be below the maximum value. Before a phone model is available for sale to the public, it is tested to confirm compliance with the guidelines. The tests are performed in positions and locations (e.g., at the ear and worn on the body) that conform to a uniform testing methodology determined by an expert standards body.

The highest SAR level recorded from this product was 0.963 W/Kg which was below the uncontrolled (i.e., general population) limit. While there may be differences between the SAR levels of various phones and at various positions, they all meet the governmental requirements.

The International Agency for Research on Cancer (IARC) concluded in May, 2011 that there is limited evidence to suggest a possible link between RF signals and two specific types of cancer. The IARC's conclusion is based on its review of existing studies and information.

The FCC and FDA, however, indicated that there is not sufficient scientific evidence to support a link between wireless device use and cancer and that use of wireless phones according to current regulations is safe. Reference websites:









- www.fcc.gov/guides/wireless-devices-and-health-concerns
- <https://www.fda.gov/Radiation-EmittingProducts/RadiationEmittingProductsandProcedures/>

If you wish to reduce your exposure to RF energy, you can limit the amount of time you use the phone and increase the distance between the phone/antenna and your body when you use it. For example, you may use the phone's speakerphone feature or use with a wired earpiece and microphone to increase distance when you use the phone.

PLEASE NOTE THAT MODIFICATIONS TO THIS PRODUCT MODEL COULD CAUSE DIFFERENCES IN THE SAR VALUE FOR LATER PRODUCTS; IN ALL CASES, PRODUCTS ARE DESIGNED TO BE WITHIN THE GUIDELINES.

Batteries

All batteries may cause serious injury or property damage, particularly if handled improperly or used after damage.

 WARNING!	
	Failure to follow these safety instructions could result in serious injury or death caused by fire, explosion, leakage, or other hazard.
	Do not disassemble, crush, puncture, shred or otherwise attempt to change the form of the battery.
	Do not let the Iridium 9555 device or battery come in contact with water. Water can lead to corrosion of the circuits.
	Do not allow the battery to touch metal objects. Contact with metal objects can cause the battery to heat and possibly explode.
	Do not place your battery near a heat source. Excessive heat can damage the Iridium 9555 device or battery by causing it to swell, leak or malfunction.
	Do not dry a wet or damp battery with an appliance or heat source, such as a hair dryer or microwave oven.
	Do not leave the Iridium 9555 device in an automobile or other vehicle with high temperatures.
	Do not drop the battery or the Iridium 9555 device because the impact can damage them. Contact your service provider or Iridium if your Iridium 9555 device or battery has been damaged from being dropped or exposed to high temperatures.

Important: Use only Iridium original products for safety and quality assurance. Iridium's warranty does not cover damage caused by use of non-Iridium batteries.

Battery Charging

Important: Follow these guidelines when charging your battery:

- Keep the battery at room temperature. Never expose batteries to temperatures below 0°C (32°F) or above 45°C (113°F) when charging.
- New batteries are not fully charged and may take more time to charge.



Battery Disposal

Proper battery disposal is not only important for safety but also benefits the environment. Consumers should recycle used batteries and telephones in accordance with applicable national, state or local laws and regulations.

Under EU requirements, all electrical and electronic products must be taken to separate collection at the end of their working life and must not be disposed of as unsorted municipal waste.

WARNING!



Do not dispose of your battery in a fire, because this may cause an explosion resulting in serious injury or death.

Emergency Calling

CHECK WITH YOUR SERVICE PROVIDER FOR LOCAL EMERGENCY NUMBERS (full international access code, country code, and phone number) for all locations outside the United States and mainland Australia. Iridium currently only supports in-country emergency call routing to 911 within the United States and to Triple Zero (000) or 112 within mainland Australia.

Outside of the United States and mainland Australia, calls to emergency access numbers such as 999, are not able to be made on the Iridium system. When placing a call to an emergency operator or local public safety answering point, always verbally report your location to assist first responders with identifying your location to provide assistance. Caller location identification is not automatically transmitted on the Iridium system.

Iridium does not guarantee network availability at all times due to situations where the network is unavailable due to satellite availability,

terrain, weather, or other conditions that may prevent an emergency call from being placed.

EMERGENCY CALLS WITHIN THE UNITED STATES: Power on the Iridium 9555 Satellite Phone, extend the antenna towards the open sky, confirm proper registration & signal strength on the display, dial 911 and press the green send key. Verbally report the situation and your location to the operator for assistance. The Iridium service does not provide enhanced 911 service which automatically identifies the caller location.

EMERGENCY CALLS WITH MAINLAND AUSTRALIA: Power on the Iridium 9555 Satellite Phone, extend the antenna towards the open sky, confirm proper registration & signal strength on display, dial Triple Zero (000) or 112 depending upon your service provider's instructions, and press the green send key. Verbally report the situation and your location to the operator for assistance. The Iridium service does not provide enhanced emergency calling service which automatically identifies the caller location.

EMERGENCY CALLS IN ALL OTHER LOCATIONS: You will need to obtain and dial the full international access code, country code, and phone number for the local fire, police, or ambulance depending upon the nature of the emergency. Power on the Iridium 9555 Satellite Phone, extend the antenna toward the open sky, confirm proper registration & signal strength on the display, dial the local emergency number obtained from your service provider or local advisor and press the green send key. Verbally report the situation and your location to the operator for assistance. The Iridium service does not provide enhanced emergency calling service which automatically identifies the caller location.

Antenna Care

Use only the supplied or an approved replacement antenna. Unauthorized antennas, modifications, or attachments could damage the phone and may violate government regulations. When using remote mount antenna, mount antenna at least 20 cm away from the user. Also, when using a remote mount antenna in order to reduce potential radio interference to other users, the antenna type and its gain should be so chosen such that the equivalent isotropically radiated power (EIRP) is not more than that permitted for successful communication and the peak gain of the antenna should be no greater than 3.0dBi.

Driving and Operation of Other Motor Vehicles

The use of any wireless device, including a satellite telephone, may cause distraction. Discontinue a call if you cannot concentrate on driving. Check the laws and regulations on the use of wireless telephones in the areas where you drive. Always obey them. Many local governments prohibit the

use of mobile telephones while driving. Observe the following guidelines when using your phone while driving:

- Give full attention to driving—driving safely is your first responsibility.
- Use hands-free phone operation, if available.
- Pull off the road and park safely before making or answering a call.

Posted Facilities

Turn your phone OFF in any facility where posted notices so require.



Blasting Areas

To avoid interfering with blasting operations, turn your phone OFF when in a “blasting area” or in areas posted: “Turn off two-way radio.” Obey all signs and instructions. Failure to do so could result in serious injury or death.

Potential Explosive Atmospheres

Areas with a potentially explosive atmosphere are often but not always clearly marked. They include, but are not limited to: fueling areas such as gasoline stations; below deck on boats; fuel or chemical transfer or storage facilities; areas where fuel odors are present (for example, if a gas/propane leak occurs in an automobile or home); areas where the air contains chemicals or particles, such as grain, dust, or metal powders; and any other area where you normally would be advised to turn off your vehicle engine.

Turn your phone OFF and do not remove, install or charge your battery when you are in any area with a potentially explosive atmosphere. Obey all signs and instructions. Sparks from your battery in such areas could cause an explosion or fire resulting in serious injury or death.

Electronic Devices

Most electronic equipment is subject to interference from RF energy from external sources if inadequately shielded. In some circumstances your mobile device may cause interference with other devices. Turn off your phone in any location where posted notices instruct you to do so.

For optimal performance and to be sure that exposure to RF energy does not exceed guidelines set forth in the relevant standards discussed in “Exposure to Radio Frequency Signals” on page 4 and “Specific Absorption Rate Data” on page 4, always follow the instructions and precautions.

Product Operation

If you wear the satellite phone on your body, always place it in an Iridium leather case. Refer to www.iridium.com.

Using accessories not supplied by Iridium may cause your satellite phone to exceed RF energy exposure guidelines.

Radio Interference

Your satellite phone contains digital circuits for the display of data and connection to a personal computer. Emissions from these circuits can cause radio interference. With respect to such circuits, this device complies with Part 15 of the FCC Rules. Operation is subject to the following two conditions: (1) this device may not cause harmful interference, and (2) this device must accept any interference received, including interference that may cause undesired operation. Any unauthorized antennas, modifications or attachments could damage the Iridium 9555 device and may violate FCC regulations and void your authority to operate the device.

This equipment has been tested and found to comply with the limits for a Class B digital device, pursuant to Part 15 of the FCC Rules. These limits are designed to provide reasonable protection against harmful interference in a residential installation. This equipment generates, uses and can radiate radio frequency energy and, if not installed and used in accordance with the instructions, may cause harmful interference to radio communications. However, there is no guarantee that interference will not occur in a particular installation. If this equipment does cause harmful interference to radio or television reception, which can be determined by turning the equipment off and on, the user is encouraged to try to correct the interference by one or more of the following measures:

- Reorient or relocate the receiving antenna.
- Increase the separation between the equipment and receiver.
- Connect the equipment into an outlet on a circuit different from that to which the receiver is connected.
- Consult the dealer or an experienced radio/TV technician for help.

Implantable Medical Devices

If you have an implantable medical device such as a pacemaker or defibrillator, the Health Industry Manufacturers Association recommends that a minimum separation of six inches (6") be maintained between a handheld wireless phone and a pacemaker to avoid potential interference

with the pacemaker. These recommendations are consistent with the independent research by and recommendations of Wireless Technology Research.

WARNING!

Persons with pacemakers:

- Should ALWAYS keep the phone more than eight(8)" from their pacemaker when the phone is turned ON.
- Should not carry the phone in a breast pocket.
- Should use the ear opposite the pacemaker to minimize the potential for interference.
- Should turn the phone OFF immediately if there is any reason to suspect that interference is taking place.
- Failure to heed this warning could result in serious injury or death.

Hearing Aids

Some digital wireless phones may interfere with some hearing aids. In the event of such interference, you may want to consult your hearing aid manufacturer to discuss alternatives.

WARNING!

Extended Exposure to Loud Noise



Exposure to loud noise from any source for extended periods of time may affect your hearing. The louder the volume sound level, the less exposure is required to affect your hearing. To protect your hearing:

- Limit the amount of time you use headsets or headphones at high volume.
- Avoid turning up the volume to block out noisy surroundings.
- Turn the volume down if you cannot hear people speaking near you.
- Failure to heed this warning could result in serious injury or death.

Other Medical Devices

If you use any other personal medical device, consult the manufacturer of your device to determine if it is adequately shielded from external RF energy. Consult your physician to determine compatibility with your medical device.

Turn your phone OFF in health care facilities when any regulations posted in these areas instruct you to do so. Hospitals or health care facilities may be using equipment that could be sensitive to external RF energy.

Aircraft

Airline regulations prohibit using your phone while in the air. Check and comply with the policy of your airline regarding the use of your phone while the aircraft is on the ground.

Switch OFF your phone before boarding an aircraft.

Vehicles

RF signals may affect improperly installed or inadequately shielded electronic systems in motor vehicles. Check with the manufacturer or its representative regarding your vehicle. You should also consult the manufacturer of any equipment that has been added to your vehicle.

Vehicles Equipped with an Air Bag

An air bag inflates with great force. Do NOT place objects, including installed or portable wireless equipment, in the area over the air bag or in the air bag deployment area. If in-vehicle wireless equipment is improperly installed, serious injury could result.

WARNING!

Adult Use Only

Keep your phone and accessories away from children. These products are not toys and may be hazardous to small children. For example:

- A choking hazard may exist for small, detachable parts.
- Improper use could result in loud sounds, causing hearing injury.
- Improperly handled batteries could over heat and cause a burn.
- Failure to heed this warning could result in serious injury or death.

Glass Parts

Some parts of your satellite phone may be made of glass. This glass could break if the product is dropped on a hard surface or receives a substantial impact. If glass breaks do not touch or attempt to remove. Stop using the phone until the glass is replaced by a qualified service center.

WARNING!

Seizures and Blackouts

Some people may be susceptible to epileptic seizures or blackouts when exposed to flashing lights, such as when playing video games. If you or your family members have a history of such seizures or blackouts, please consult your physician before enabling a flashing lights feature on your phone. Discontinue use or consult a physician if any of the following symptoms occur: convulsion, eye or muscle twitching, loss of awareness, involuntary movements or disorientation. Failure to heed this warning could result in serious injury or death.

Repetitive Motion

When you repeatedly perform actions such as pressing keys or entering finger-written characters, you may experience occasional discomfort in your hands, arms, shoulders, neck or other parts of your body. If you continue to have discomfort during or after such use, stop use and see a physician.

3: Iridium 9555 Satellite Phone Overview

Guide Overview

This chapter provides a complete tour of the Iridium 9555 Satellite Phone. You will discover all the features and components that you need to operate your phone to its full potential.

For ease of use, the chapters in this manual are divided by menu options. Each section of the chapter is then divided by the same sub-menu options as your phone. Just follow the sequence of menus on your phone, the manual will follow along, making the startup process a simple one.



Phone Overview

Front View



Side View

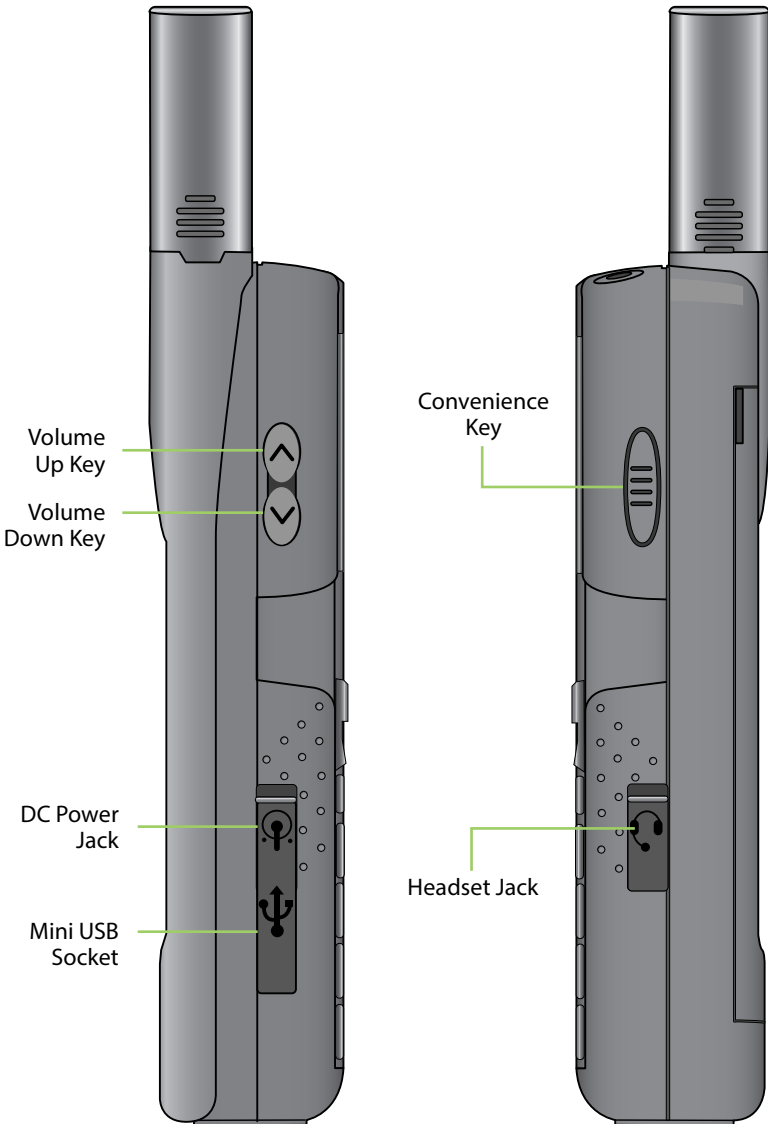

Back View

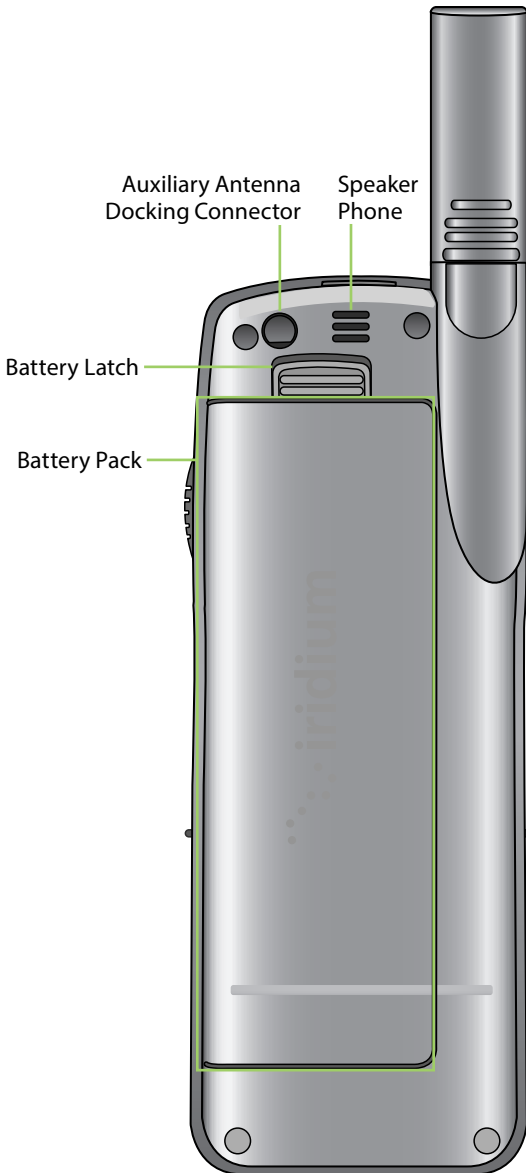

Accessories

AC Travel Charger and International Plug Kit

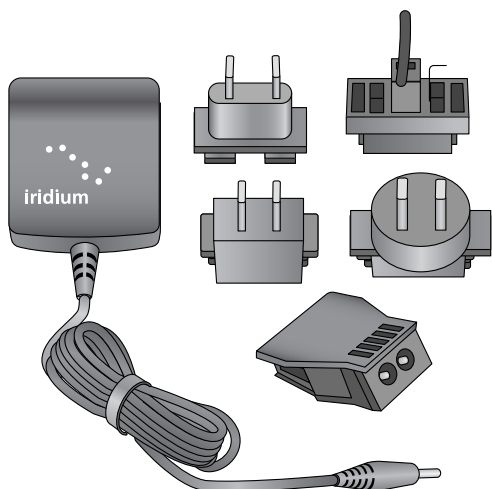

The AC Travel Charger and International Plug Kit provides rapid charge for optimal performance.

- Can be used to power the phone when the battery is depleted.
- The battery must be installed when using the charger to power the phone.
- Includes five international plug adapters for use in many countries around the world.
- Allows you to use the Iridium 9555 Satellite Phone while recharging the battery. The battery should not be allowed to discharge fully.

Note: This charger has been certified for use at elevations up to 2,000 meters above sea level.

Headset

The convenient headset provides both an earphone and microphone in one small piece for simple hands-free and private telephone conversations. The headset plugs directly into the jack on the right side of your phone.

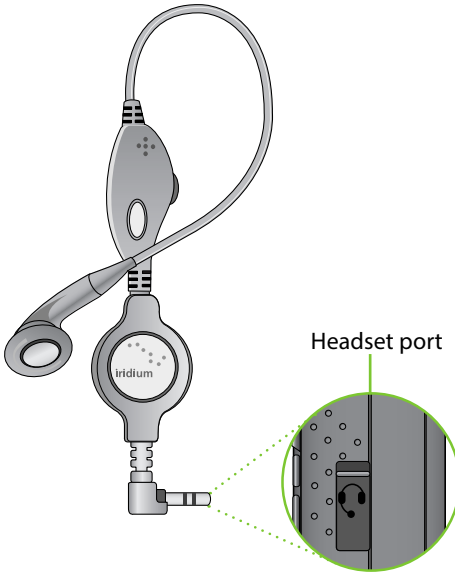

Auto Accessory Adaptor

The AC Travel Charger and International Plug Kit provide rapid charge for optimal performance.

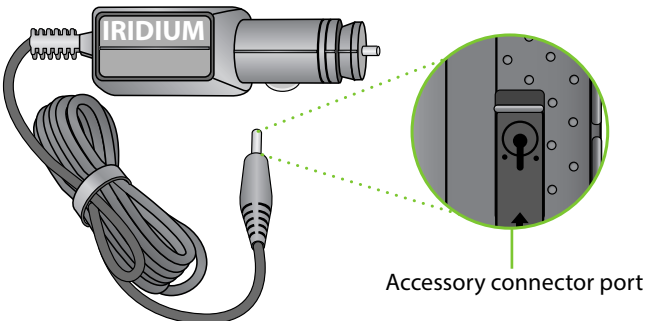

To install the Antenna Adaptor

1. Slide the phone into the antenna adaptor.

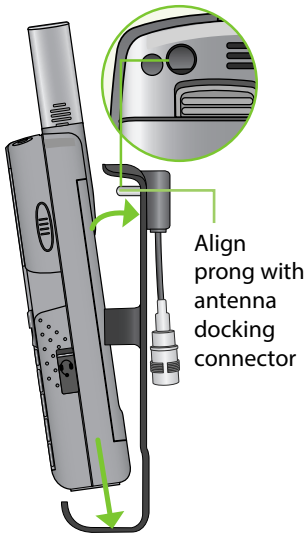

2. Rotate until the back of the phone meets the adaptor.

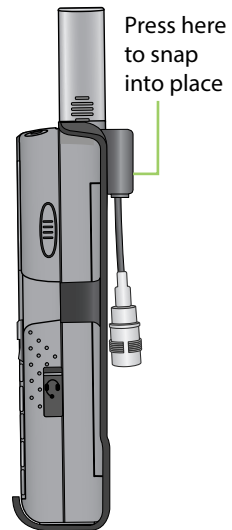

Note: Your phone was shipped with a plug protector for the antenna connector. You must remove this prior to using the Antenna Adaptor.

Auxiliary Antenna Adaptor

The Antenna Adapter allows you to connect your Iridium 9555 Satellite Phone to an external antenna. The adapter uses a TNC female connector to attach to an antenna cable with a TNC male connector. For a list of available accessory options, visit www.iridium.com.

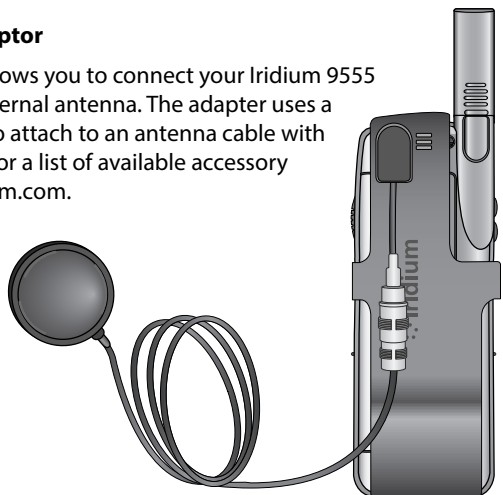

Indicators



Status Indicator LED

The status indicator at the top of the phone has the following meanings:

LED is ...	Indicates
Alternating red and green	Call in progress; ringing, dialing or in call.
Flashing green	Network is available and SIM status okay. Phone is idle.
Flashing yellow	SIM problem; this signifies a problem with the SIM, such as; locked, missing or invalid.
Flashing red	No connection to network.

Display Status Indicators and Icons

The following icons appear in your display to provide you with information about the phone's activity.

Main Screen Components

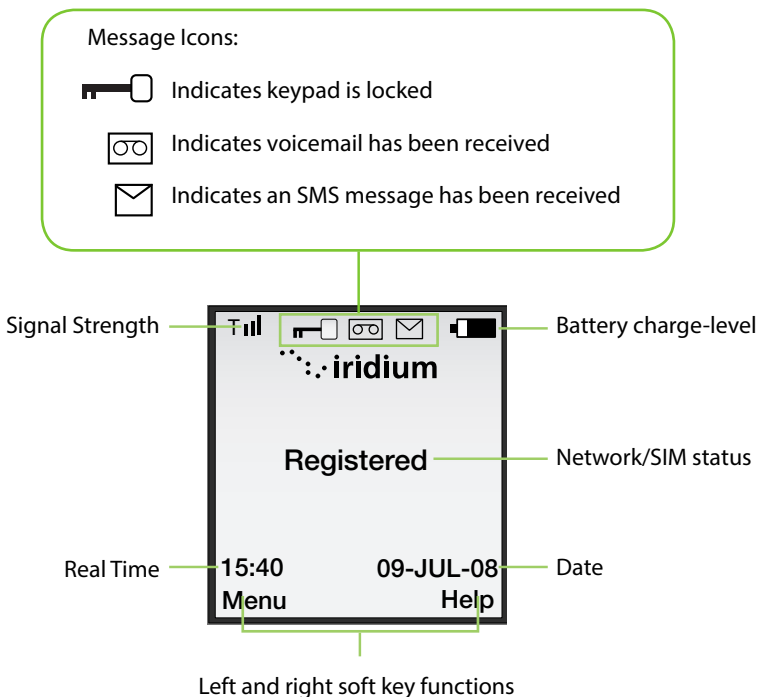

Menu Components

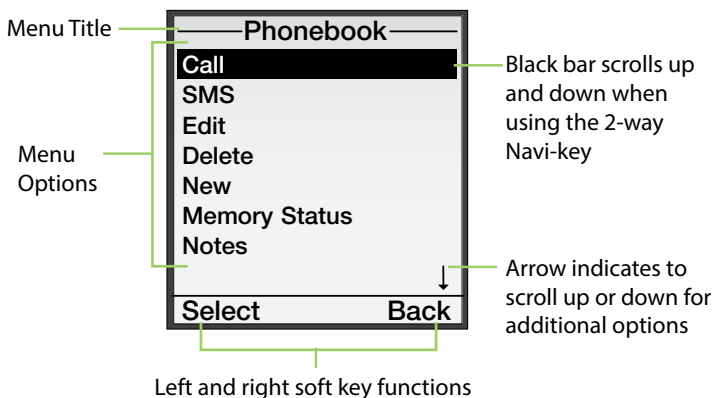

4: Getting Started

Using the SIM Card

You will receive a Subscriber Identity Module (SIM) card from your service provider that is required for use with your phone. The SIM card is a smart card that contains your service details and memory for storing phone book entries and messages.

Your phone has limited functionality without the SIM card, so you want to install the card before using your phone.

SIM Card Care

You may want to keep your card with you when you are not using your phone. This helps keep your personal information secure and gives you access to your service even if your phone is not available.

Important: Do not bend or scratch your SIM card, and avoid exposing your card to static electricity, water or dirt.

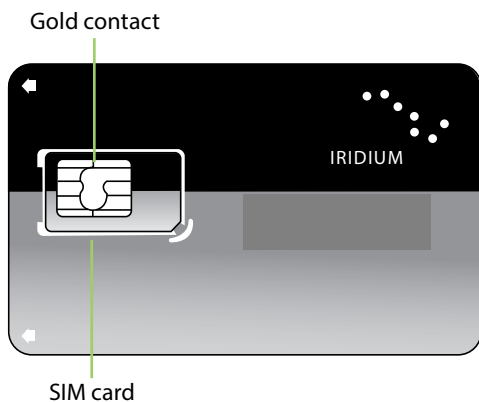

Insert the SIM Card

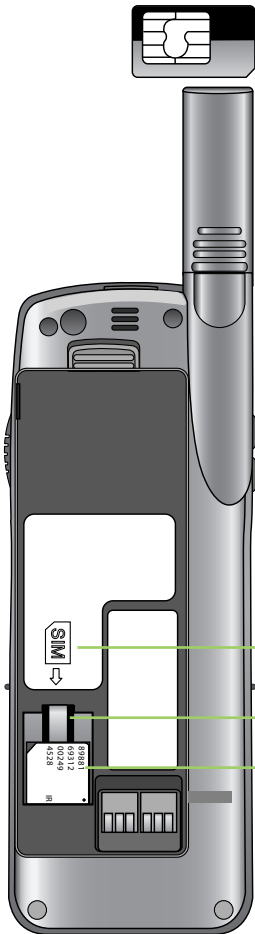

1. Remove the SIM card from the larger card.
2. Remove the battery as shown on page 29.
3. Slide the SIM card into the SIM card slot.
Follow the card orientation shown on the decal. Be sure the gold contact is facing down.

The card is held in place by a small retaining clip.









- SIM Decal
- Retaining Clip
- SIM Card

Remove the SIM Card

Press down on the retaining clip and slide the SIM card out of the slot.

Battery Pack Information

All batteries may cause serious injury or property damage, particularly if handled improperly or used after damage.

 WARNING!	
	Failure to follow these safety instructions could result in serious injury or death caused by fire, explosion, leakage, or other hazard.
	Do not disassemble, crush, puncture, shred or otherwise attempt to change the form of the battery.
	Do not let the Iridium 9555 device or battery come in contact with water. Water can lead to corrosion of the circuits.
	Do not allow the battery to touch metal objects. Contact with metal objects can cause the battery to heat and possibly explode.
	Do not place your battery near a heat source. Excessive heat can damage the Iridium 9555 device or battery by causing it to swell, leak or malfunction.
	Do not dry a wet or damp battery with an appliance or heat source, such as a hair dryer or microwave oven.
	Do not leave the Iridium 9555 device in an automobile or other vehicle with high temperatures.
	Do not drop the battery or the Iridium 9555 device because the impact can damage them. Contact your service provider or Iridium if your Iridium 9555 device or battery has been damaged from being dropped or exposed to high temperatures.

Important: Use only Iridium original products for safety and quality assurance. Iridium's warranty does not cover damage caused by use of non-Iridium batteries.



Battery Disposal

Proper battery disposal is not only important for safety but also benefits the environment. Consumers should recycle used batteries and telephones in accordance with applicable national, state or local laws and regulations.

Under EU requirements, all electrical and electronic products must be taken to separate collection at the end of their working life and must not be disposed of as unsorted municipal waste.

WARNING!



Do not dispose of your battery in a fire, because this may cause an explosion resulting in serious injury or death.

Remove and Install the Battery Pack

The back panel of the phone is the battery pack. You need to remove the battery pack to insert the SIM card or replace the battery.

To Remove the Battery Pack

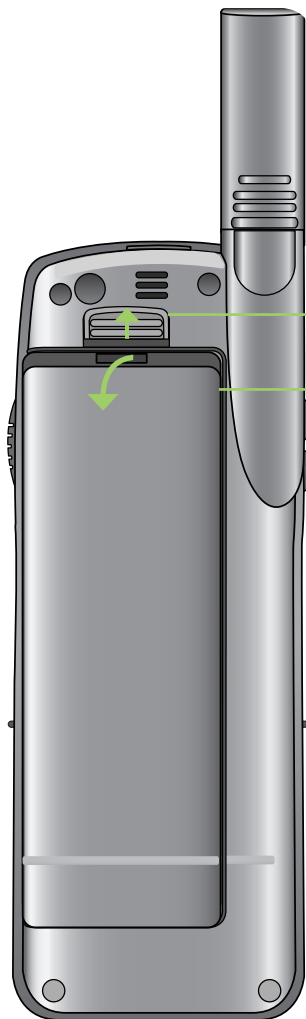

1. Push the battery latch up.
The battery pack will release.
2. Lift the battery pack away from the phone by pulling from the side notch.

To Install the Battery Pack

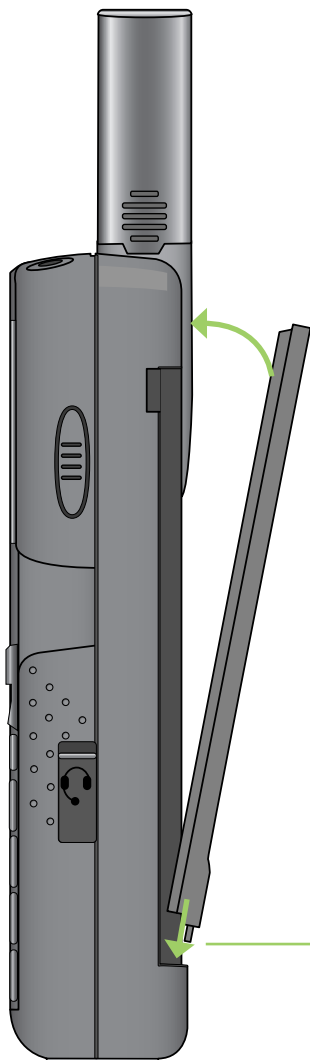

1. Align the battery pack pegs with the slots on the bottom of the battery compartment.
2. Rotate the top end of the battery pack into the Iridium 9555 Satellite Phone. Press the battery until it is flush with the case.

Note: The battery should click into place and held securely by the battery latch.

Battery pack pegs

Charging the Battery

Use the AC travel charger or auto accessory adapter to charge the Iridium 9555 Satellite Phone.

Important: Follow these guidelines when charging your battery:

- Keep the battery at room temperature. Never expose batteries to temperatures below 0°C (32°F) or above 45°C (113°F) when charging.
- New batteries are not fully charged and may take more time to charge.

Charge the Battery Pack

1. Connect the travel charger or auto accessory adapter to the phone by removing the rubber connector cover and inserting the charging connector.



2. Plug the AC travel charger or auto accessory adapter into the appropriate power source. The phone beeps.
3. The battery symbol on the LCD display flashes.

Note: Calls can still be made or received while the battery is charging; however, the battery charges faster if the phone is turned off. When the Iridium 9555 Satellite Phone is not in use the battery takes approximately 4 hours to fully charge.

You must wait a minimum of 5 seconds before powering on the Iridium 9555 Satellite Phone after you have disconnected from the charger.

Checking Battery Charge Level

Low Battery Warning

Your phone has two ways to indicate that the battery is low and only a few minutes of talk time remains:

1. The battery charge indicator appears continuously in the upper right hand corner of the display. When the battery charge is low the icon appears empty, and Low Battery appears on the display.

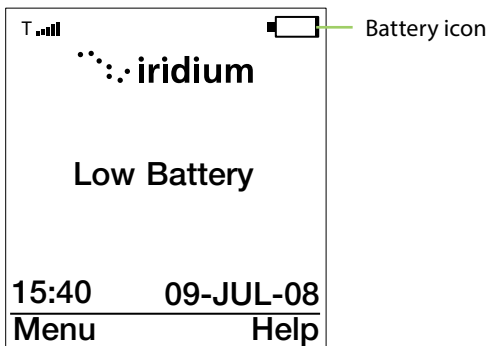

2. A warning tone (two double beeps) sounds.

Note: To help maintain the best battery and phone performance, recharge your battery as soon as possible after you receive the low battery warning.

Start-up Procedure

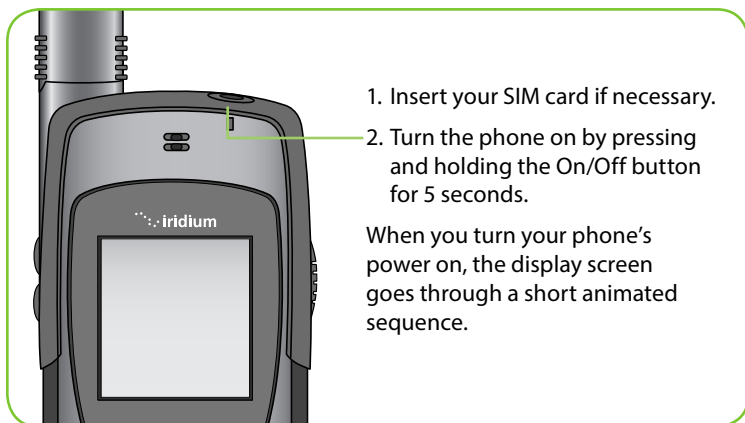

WARNING!

Blasting Areas

To avoid interfering with blasting operations, turn your phone OFF when in a “blasting area” or in areas posted: “Turn off two-way radio.” Obey all signs and instructions. Failure to do so could result in serious injury or death.

Potential Explosive Atmospheres

Areas with a potentially explosive atmosphere are often but not always clearly marked. They include, but are not limited to: fueling areas such as gasoline stations; below deck on boats; fuel or chemical transfer or storage facilities; areas where fuel odors are present (for example, if a gas/propane leak occurs in an automobile or home); areas where the air contains chemicals or particles, such as grain, dust, or metal powders; and any other area where you normally would be advised to turn off your vehicle engine.

Turn your phone OFF and do not remove, install or charge your battery when you are in any area with a potentially explosive atmosphere. Obey all signs and instructions. Sparks from your battery in such areas could cause an explosion or fire resulting in serious injury or death.

Power on Message

Once your phone is on, one of the following messages may appear.

Message	Directive
Bad Card	See Supplier. Your SIM card has been damaged or incorrectly issued. Contact your service provider for information.
Check Card	The SIM card is damaged or inserted the wrong way.
Denied	Your phone has seen a network, but has been denied access.
SIM PIN	Enter the four- to eight-digit SIM card PIN code provided by your service provider and press OK to proceed. See "Using the Security Menu" on page 157, for more information about your SIM.
Invalid Account	Contact your service provider.
Phone PIN	The phone has been locked. To unlock the phone, you must enter the correct Phone PIN number.
PIN Blocked	When the PIN number has been entered incorrectly three times in a row, the phone automatically blocks the PIN. To unblock the pin, enter the PUK1 code for the phone by entering **05* from the main screen.
Searching for Iridium...	The phone is attempting to establish communications with the satellite network. This message appears while your phone searches for a network connection.

Message	Directive
Registered	Your phone is now registered with the network.
PIN 2 Blocked	<p>When the PIN2 number has been entered incorrectly three times in a row, the phone automatically blocks the PIN.</p> <p>To unblock the PIN2 enter the PUK2 code for the phone by entering **052* from the main screen.</p>

Phone Operation

Normal Operation

Hold the phone as you would any other telephone. Fully extend the antenna then rotate the antenna to either the left or right detent. The antenna should be vertical to the ground and have a clear unobstructed view of the sky.

WARNING!

Extended Exposure to Loud Noise



Exposure to loud noise from any source for extended periods of time may affect your hearing. The louder the volume sound level, the less exposure is required to affect your hearing. To protect your hearing:

- Limit the amount of time you use headsets or headphones at high volume.
- Avoiding turning up the volume to block out noisy surroundings.
- Turn the volume down if you cannot hear people speaking near you.
- Failure to heed this warning could result in serious injury or death.

WARNING!

Persons with pacemakers:

- Should ALWAYS keep the phone more than eight (8)" from their pacemaker when the phone is turned ON.
- Should not carry the phone in a breast pocket.
- Should use the ear opposite the pacemaker to minimize the potential for interference.
- Should turn the phone OFF immediately if there is any reason to suspect that interference is taking place.
- Failure to heed this warning could result in serious injury or death.

Adult Use Only

Keep your phone and accessories away from children. These products are not toys and may be hazardous to small children. For example:

- A choking hazard may exist for small, detachable parts.
- Improper use could result in loud sounds, causing hearing injury.
- Improperly handled batteries could over heat and cause a burn.
- Failure to heed this warning could result in serious injury or death.

Seizures and Blackouts

Some people may be susceptible to epileptic seizures or blackouts when exposed to flashing lights, such as when playing video games. If you or your family members have a history of such seizures or blackouts, please consult your physician before enabling a flashing lights feature on your phone. Discontinue use or consult a physician if any of the following symptoms occur: convulsion, eye or muscle twitching, loss of awareness, involuntary movements or disorientation. Failure to heed this warning could result in serious injury or death.

Tips on Efficient Operation

For your phone to operate most efficiently:

1. Keep your phone battery charged to ensure that the phone is ready for use when needed.
2. Fully extend your antenna then rotate into position.
3. Make sure the antenna has a clear unobstructed view of the sky.
4. Do not touch the antenna unnecessarily when the phone is in use.
5. Contact with the antenna affects call quality and may cause the phone to operate at a higher power level than otherwise needed.
6. Do not wear the phone on your body while making calls with the headset accessory. Wearing the phone on the body can interfere with proper phone operation, since the antenna requires a clear unobstructed view of the sky to access the Iridium® satellite network.
7. Once you complete your call and are finished with the phone, return the antenna to the center upright position and gently retract the antenna before carrying or storing the phone between uses.
8. For backup, keep a written record of all important information stored on your phone.

Placing a Call

Before you place a call:

1. The phone must be powered on.
2. SIM card inserted.
3. Phone is unlocked.
4. Have a clear direct view of the sky to be in contact with the network.
5. Antenna should be extended and pointed up towards the sky.

Dial the Number

As you enter a phone number, the digits are displayed on a single line that scrolls across the display.

1. Enter the number using the key pad. As you begin entering digits, you see **Options** displayed above the left soft key and **Clear** displayed above the right soft key.

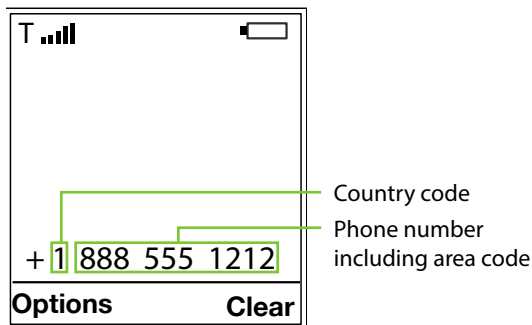

The phone number must be entered in international format: 00 or + [country code] [phone number].

Note: All Iridium subscriber numbers begin with county code of **8816** unless an alternative access number has been issued by your service provider.

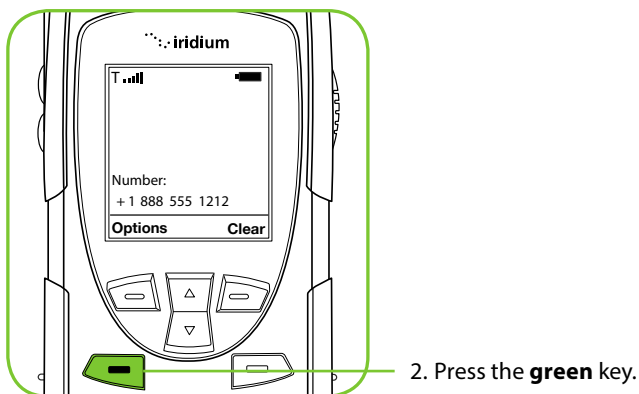

Note: You receive this message when the antenna is not fully extended from the Iridium 9555 Satellite Phone.



3. Calling followed by the number you dialed appears in the display.

If the call does not connect, one of the following messages appears.

Message	Directive
Busy Try Later Or Please Try Later	The phone is unable to access the network. Try again in a few minutes
Could not place call. No connection to the network	The phone is unable to access the network.
Restricted Area	The phone is unable to access the network. Move to an area where calls are allowed.

Note: If you have disabled the timer, **Connected** is displayed.

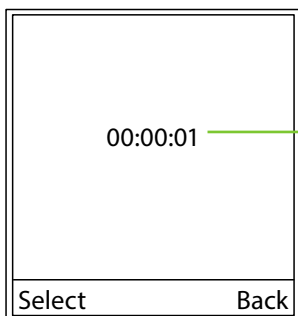

4. A timer keeps track of the duration of each call.

End a Call

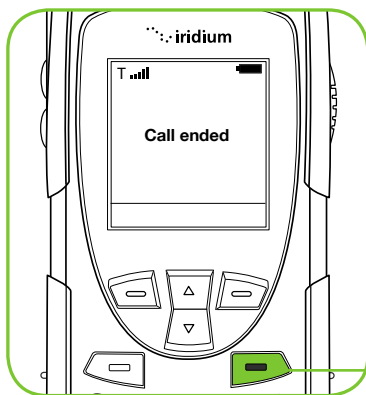

Press the **red** key.

Re-dial Last Number Called

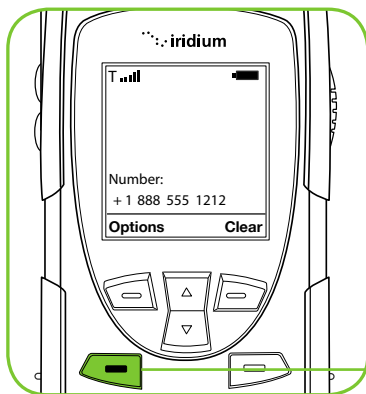

Press the **green** key twice.

Receiving a Call

Before you receive a call:

1. The phone must be powered on.
2. A valid SIM card must be inserted.
3. Phone is unlocked.
4. The phone must be connected with the network.

There are two scenarios for receiving calls depending on the antenna position:

1. Antenna extended.
2. Antenna stowed; that is, in the down position.

Receiving a call with the Antenna Extended

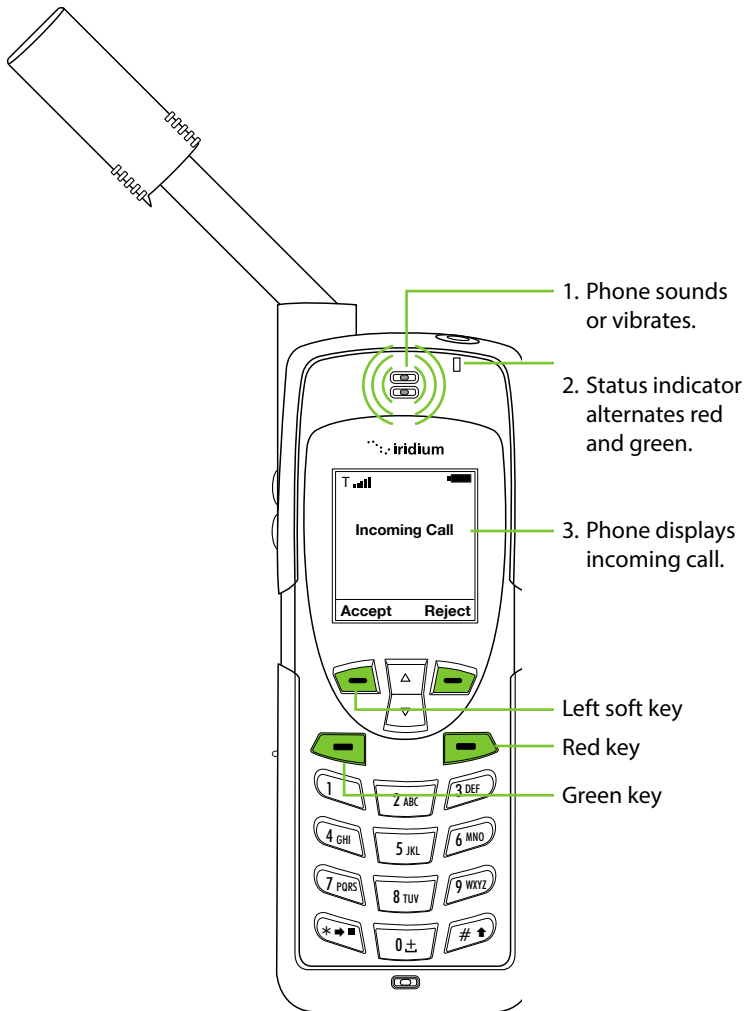

Answering the call with the Antenna Extended

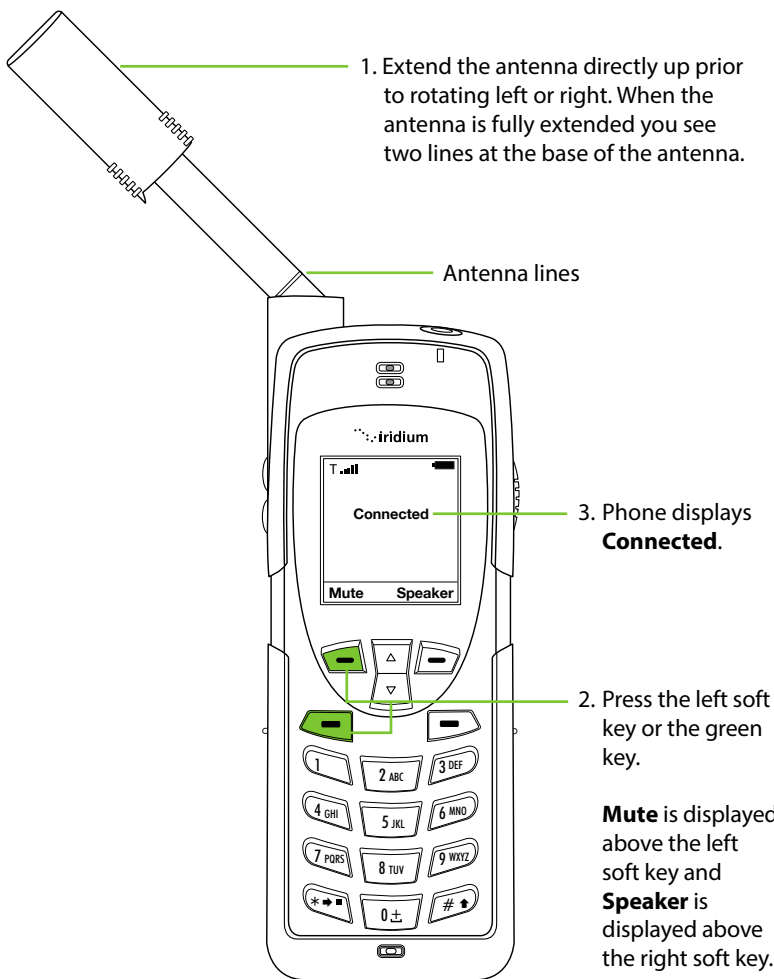

If the call does not connect properly, the following message appears:

Message	Directive
Call Failed	The antenna is not properly positioned or the network signal is not strong enough.

Receiving a Call with the Antenna Stowed

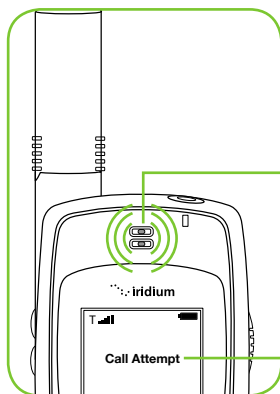

1. The phone displays the alert – or you're prompted to extend the antenna.

2. The phone displays **Call Attempt**.

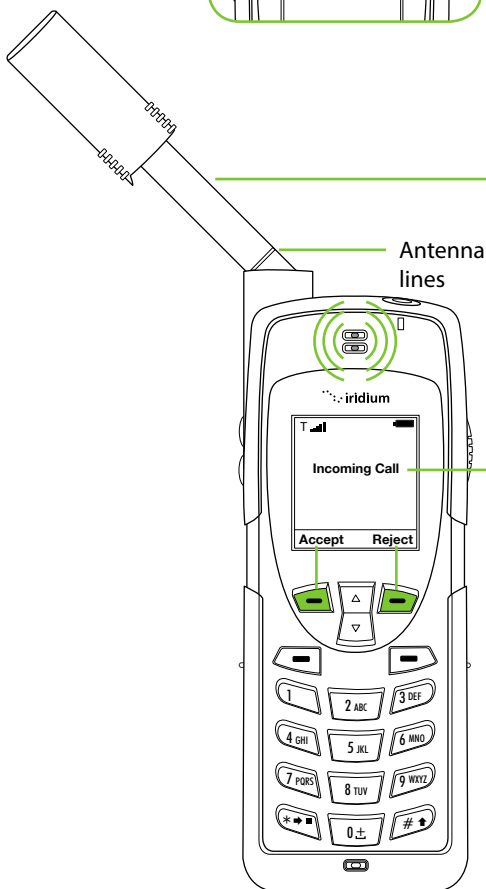

3. Extend the antenna directly up prior to rotating left or right. When the antenna is fully extended you see two lines at the base of the antenna.

4. After several seconds, your phone rings or vibrates, and displays **Incoming Call**. Select **Accept**, located above the **left soft key**, or **Reject**, located above the **left soft key**.

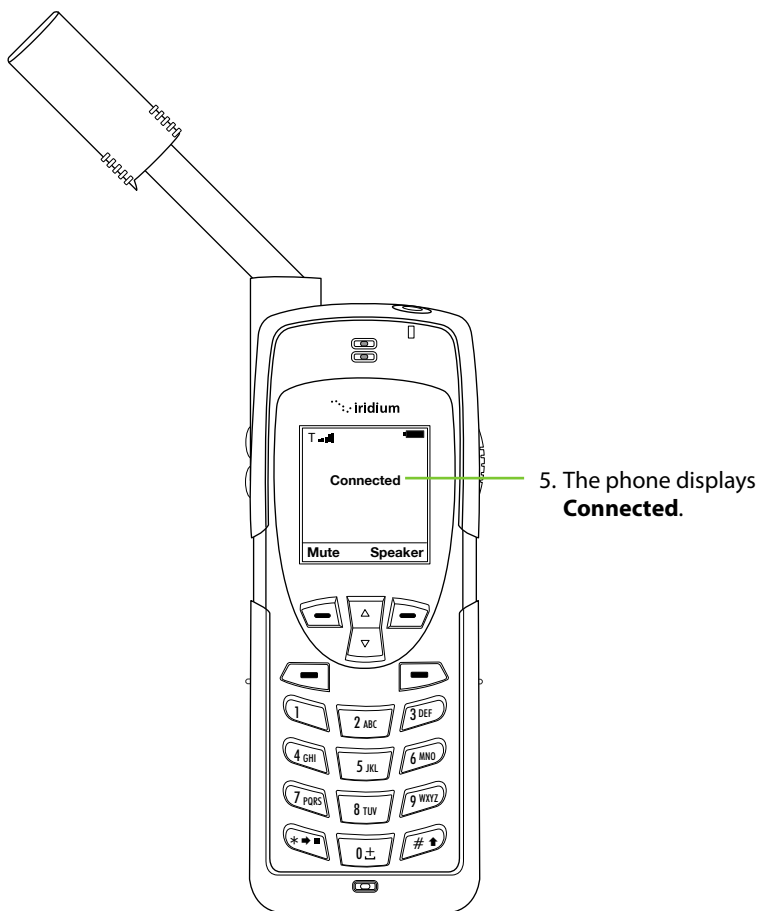

If the call does not connect properly, the following message appears:

Message	Directive
Call Failed	The antenna is not properly positioned or the network signal is not strong enough.

Muting a Call

For privacy during a call, use the mute feature. You hear the party on the other end, but they do not hear you.

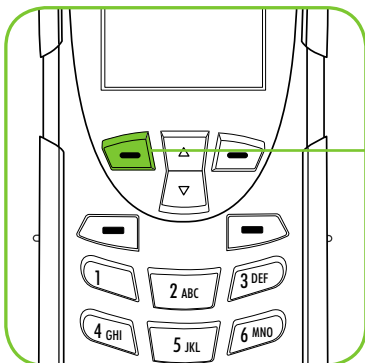

To mute the call:
Press the **left soft key**.

To un-mute the call:
Press the **left soft key** again.

Speaker Phone

To allow the call to be shared with other people within close proximity to your phone, use the speaker phone feature. In this mode the speaker in the rear of the phone is used instead of the normal earpiece/receiver.

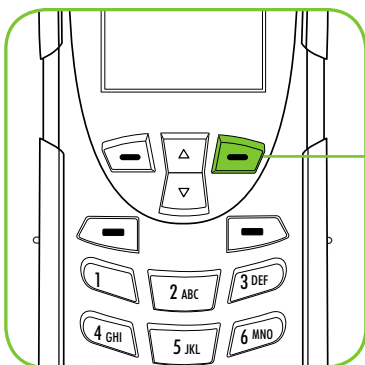

To use speaker phone: Press the **right soft key**.

To switch back to the earpiece: Press the **right soft key** again.

Speaker Volume

The speaker volume can be adjusted either while on a call or with the Volume and Tones menu located under the Setup menu.

1. Increase the speaker volume by pressing the upper volume control key, during a call. Once you are satisfied with the volume press OK. If you

would like to cancel the change to the volume press **Back**.

2. Decrease the speaker volume by pressing the **lower volume control** key, during a call.

As you press the keys, you hear the new volume level. The bar graph on the display indicates the volume level; the higher the graph, the louder the volume.

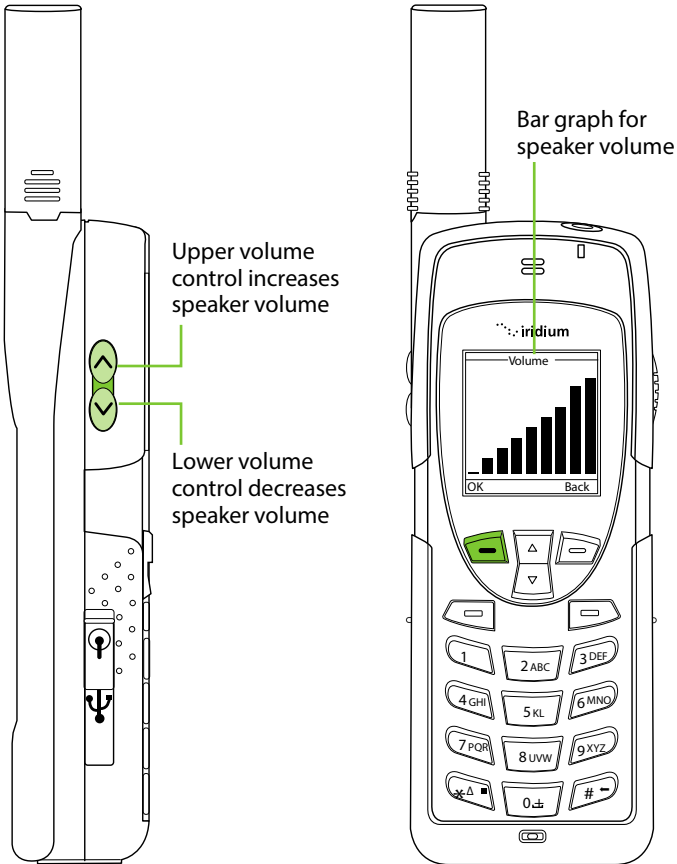

Ringer Volume

The ringer volume may be adjusted with the Volume and Tones menu located under the **Setup** menu.

- Increase the ringer volume by pressing the **upper volume control** key.
- Decrease the ringer volume by pressing the **lower volume control** key.

- As you press the keys, you hear the new volume level. The bar graph on the display indicates the volume level; the higher the graph, the louder the volume.

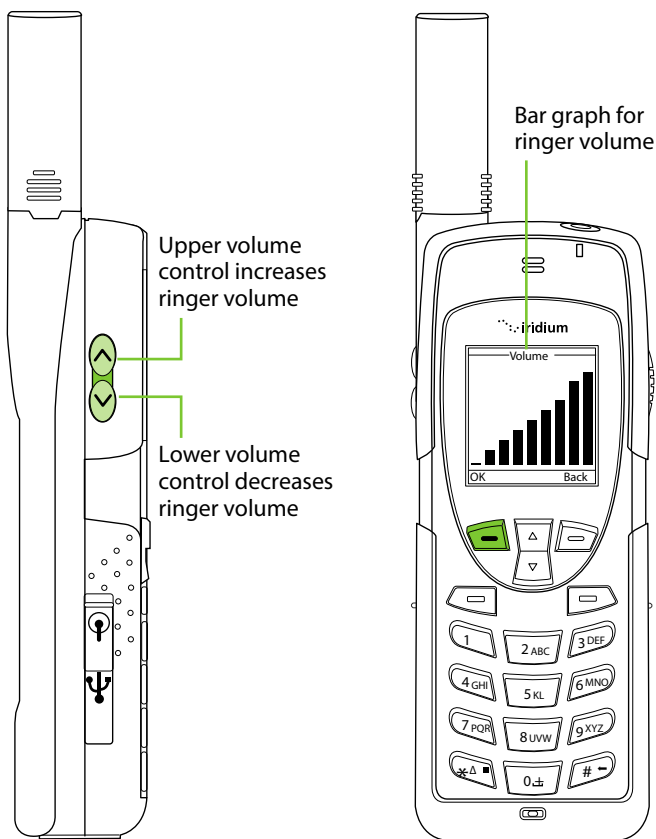

Unanswered Calls

If you are away from your phone or choose not to answer a call the screen displays the number of missed calls.

Messages from Missed Calls

If you are not able to answer your phone, or are not connected to the network, callers can leave you a voice message which can be accessed from the voicemail system. When connected to the network, a message icon appears on your screen indicating a new voicemail message.

For more information on retrieving messages, see "Using the Voicemail Menu" on page 109.

Locking and Unlocking the Keypad

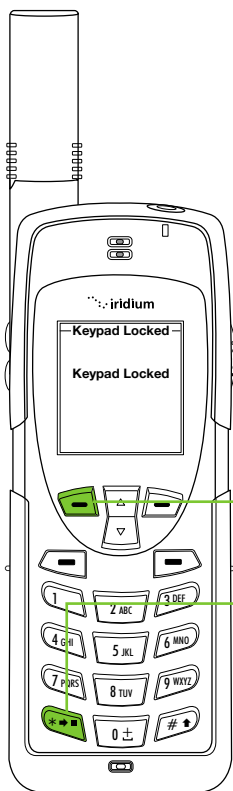

To prevent accidental phone usage you can **lock the keypad** by:

1. Press the **left soft key**, labeled **Menu**.
2. Press the *** key** to lock the keypad. A message will flash indicating the keypad is locked.

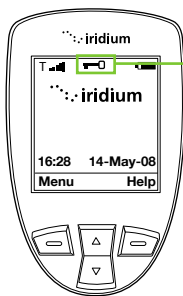

3. The **Main Screen** will now have a lock symbol.

Note: All keys with the exception of the power key are locked. You can still answer an incoming call by pressing the green key or the left soft key when the keypad is locked.

Unlocking the Keypad

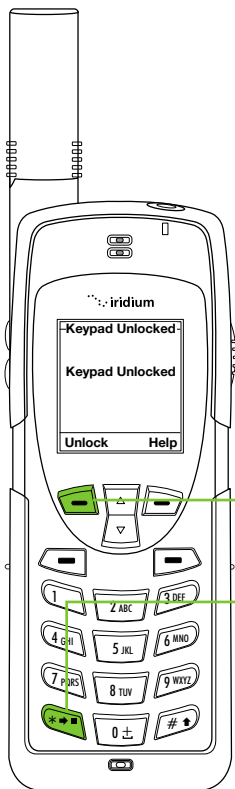

1. Press the **left soft key**, labeled **Unlock**.
2. Press the *** key**. A message flashes indicating the keypad is unlocked, and the lock symbol no longer appears on the main screen.

5: Using Menus and Keys

Many of the phone's features are organized into lists of options called menus. Use the phone keys to navigate these menus.

Using the Keys

The Soft Keys

When you press the soft keys the function appears above the key on the display screen. The function varies depending on the menu.

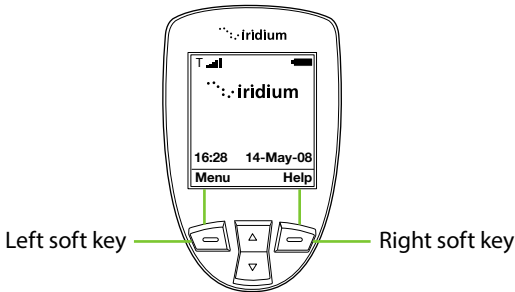

The 2-way Navi-key

Press the 2-way Navi-key up to step through the options on a menu screen.

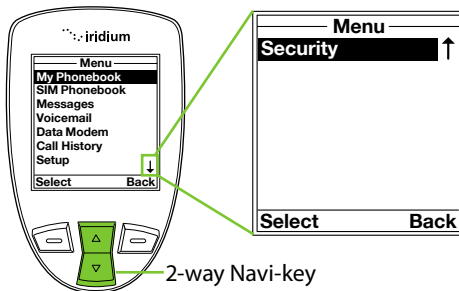

Important: When an arrow appears on the bottom of any menu screen it indicates more options to follow. To see all options, you must continue to press the 2-way Navi-key.

The Keypad

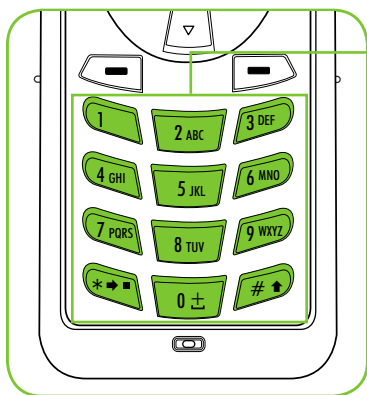

The numbered and alphabetized keys make up the Keypad. Use the keys to enter text, numbers and punctuation marks into various fields in display screens. See entering characters on page 52 for more information.

Using the Menus

To Access the Main Menu

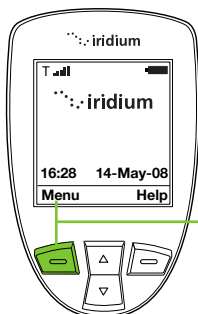

Starting from the **Main Screen**:

Press the **Left soft key**, labeled **Menu**.



The **Main Menu** appears. The Main Menu consists of:

- My Phonebook
- SIM Phonebook
- Messages
- Voicemail
- Data Modem
- Call History
- Setup
- Security
- Help

Note: You cannot access the Menus during a call.

To Access Main Menu Options

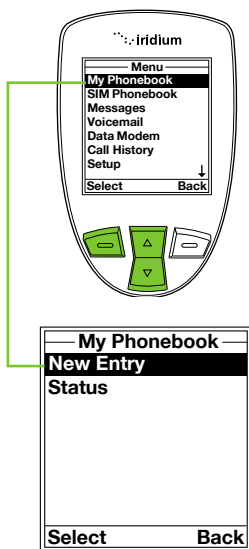

Starting from the Main Menu, use the **2-way Navi-key** to scroll to the desired menu option until it is highlighted.

Press the **left soft key**, labeled **Select**. The option you selected appears. Continue this procedure for each sub-menu.

To Return to a Menu

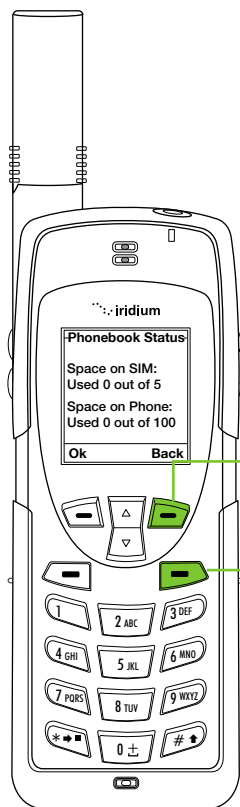

When the **right soft key** is labeled **Back**, the key will take you to the previous screen.

When the key is not labeled **Back** use the red key to return to the previous screen.

Note: In all other instances the red key will return you to the Main Screen.

Entering Characters

Many of the menu screens have fields where you need to enter information such as names and addresses. To enter this information, you need to use the keys on the keypad. Entry of text with the keys on the keypad is discussed in detail in “Traditional Text Entry” on page 55 and “Predictive Text Entry” on page 61.

When creating phonebook entries and/or composing text messages; you can use both the side volume keys and the navigation key to help navigate between characters or lines of text without deleting.

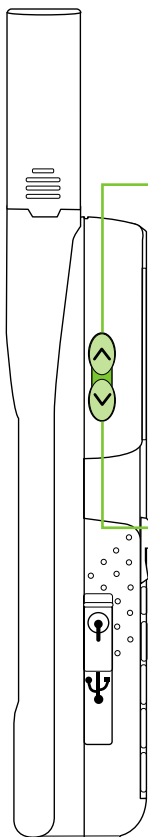

The **up volume key** takes you backwards through text when you are editing a phone book entry. If you are editing a message, it moves you up a line of text. Choosing **Up** on the **2-way Navi-key** moves backwards through message text.

The **down volume key** takes you forward through text when you are editing a phone book entry. If you are editing a message, it moves you down a line of text. Choosing **Down** on the **2-way Navi-key** moves forward through message text.

6: Traditional Text Entry

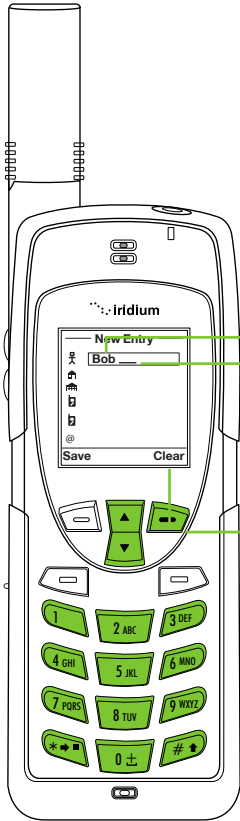

To enter characters via traditional method:

1. Enter a character by pressing the appropriate keys on the keypad. See keypad guide below.
2. The cursor moves to the next character position.
3. To delete a character press the **Right Soft Key**, labeled **Clear**.
4. Repeat steps 1 and 2 as many times as necessary.

Entering Characters

Many of the menu screens have fields where you need to enter information such as names and addresses. To enter this information you need to use the keys on the keypad. Each key represents a set of letters.



For Example: Use the number 2 key for letters A, B, and C.

- Press 1 time for A
- Press 2 times for B
- Press 3 times for C

Note: Press the **# key** to toggle between caps, lowercase, first letter capitalization, and digits. The mode currently selected is displayed in the top left corner of the screen; the modes are indicated as **ABC**, **abc**, **Abc**, **123**.

Keypad Guide

Key	Available Characters
1	. (period) /1
2	A/B/C/2
3	D/E/F/3
4	G/H/I/4
5	J/K/L/5
6	M/N/O/6
7	P/Q/R/S/7
8	T/U/V/8
9	W/X/Y/Z/9
0	_ (space)
*	next character
#	shift up
Right Soft Key	backspace / exit

Entering Punctuation and Symbols

Pressing * (**star**) **key** takes you to a symbols menu with a list of the most commonly used punctuation marks and symbols.

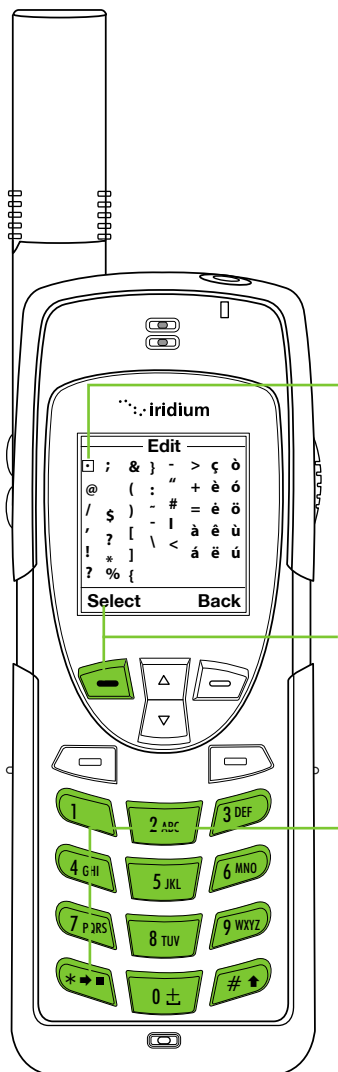

Using the **2-way Navi key**, cycle through the screen until you reach the desired symbol.

Press the **Left Soft Key** labeled **Select**.

Press the **Star** key to open the symbols menu.

Entering Numbers and Symbols into Text

There may be times when you need to add numbers into a message that you are writing. For example, to send someone a phone number as part of a text message.



Starting from a text entry field:

1. Press the **left soft key** labeled **Options**.

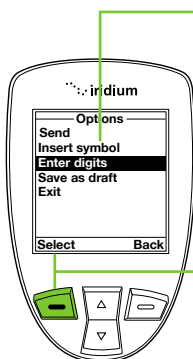

2. The **Options** screen appears. Using the **2-way Navi-key** scroll until **Enter digits** is highlighted.

3. Press the **left soft key** labeled **Select**.

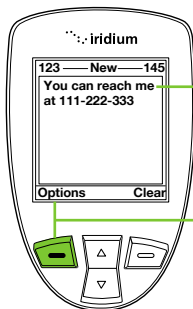

4. The original text now appears, but you are in the number entry mode.

5. Press the **left soft key** labeled **Options**.

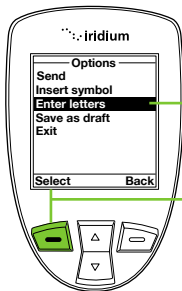

6. The **Options** screen appears. Using the **2-way Navi-key** scroll until **Enter letters** is highlighted.

7. Press the **left soft key** labeled **Options**.

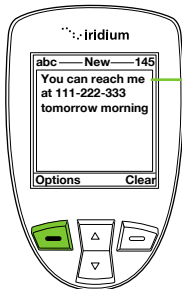

8. The original text screen now appears, and you can continue to enter text in the letter entry mode.

Note: Use this same procedure for entering symbols into text by choosing **Insert** symbol in the **Options** menu. You can also press the *** key** as a shortcut for accessing the symbol menu (see “Entering Punctuation” on page 57).

7: Predictive Text Entry

Predictive text is implemented on the Iridium 9555 Satellite Phone and affects the following areas:

- Creating an SMS/Email
- Adding Notes to an existing Phonebook entry
- Entering the Name field for a Phonebook entry (LetterWise only)

Predictive text is not set on a new phone by default, it must be enabled. To do so, start at the main screen and:

1. Press the Menu softkey
2. Select "Setup" (6 clicks down)
3. In the Setup menu, select "Language" (3 clicks down)
4. In the Language menu, select "Text entry"

In the Text entry menu, Multi-tap is the default selection. Multi-tap has no language sensitivity, other than the fact that it provides standard Western characters. To choose predictive text, select one of:

- English
- Français
- Español

Once you have made this change, all SMS entry and entry of contacts incorporate Predictive Text capabilities specific to the selected language. Once selected, select the "Back" option twice, then scroll up to "Messages" to use Predictive Text entry for messaging. To change back to "Multi-Tap" in the future, you need to adjust this setting.

Predictive text entry has the following modes:

- WordWise (Ww) which provides word prediction for users who like dictionary-based methods
- LetterWise (Lw) for letter-by-letter prediction for situations where word-based prediction doesn't afford the flexibility that may be required in some situations.

Special character entry has the following modes:

- Punctuation (#?@) for entry of punctuation and special symbols
- Digit (123) for entry of numbers

For all alphabetic languages:

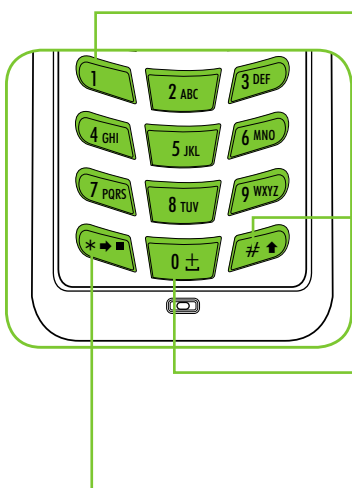

The **1 key** can be used for entering punctuation, however for full and efficient punctuation entry you can switch to **Punctuation mode (123)**.

Pressing the **Pound key (#)** switches between lower and upper case, indicated by the (↑) symbol. This is the **Shift key**.

Pressing the **Zero key (0)** enters a space, indicated by the (↵) symbol. This is the **Space key**.

Pressing the **Asterisk key (*)** enters the next word or letter, indicated by the (→) symbol. This is the **Next key**.

To complete a message, you may need to switch between these four main modes of text entry during message creation:

- WordWise (Ww) - word predictive text entry
- LetterWise (Lw) - letter-by-letter predictive text entry
- Numbers (123) - number entry (non-predictive)
- Punctuation (#?@) - punctuation entry (non-predictive)

The appropriate text entry mode can be selected by pressing the Convenience key on the side of the Iridium 9555 Satellite Phone. The active text entry mode will be displayed on the screen as indicated in the illustrations on the following page.

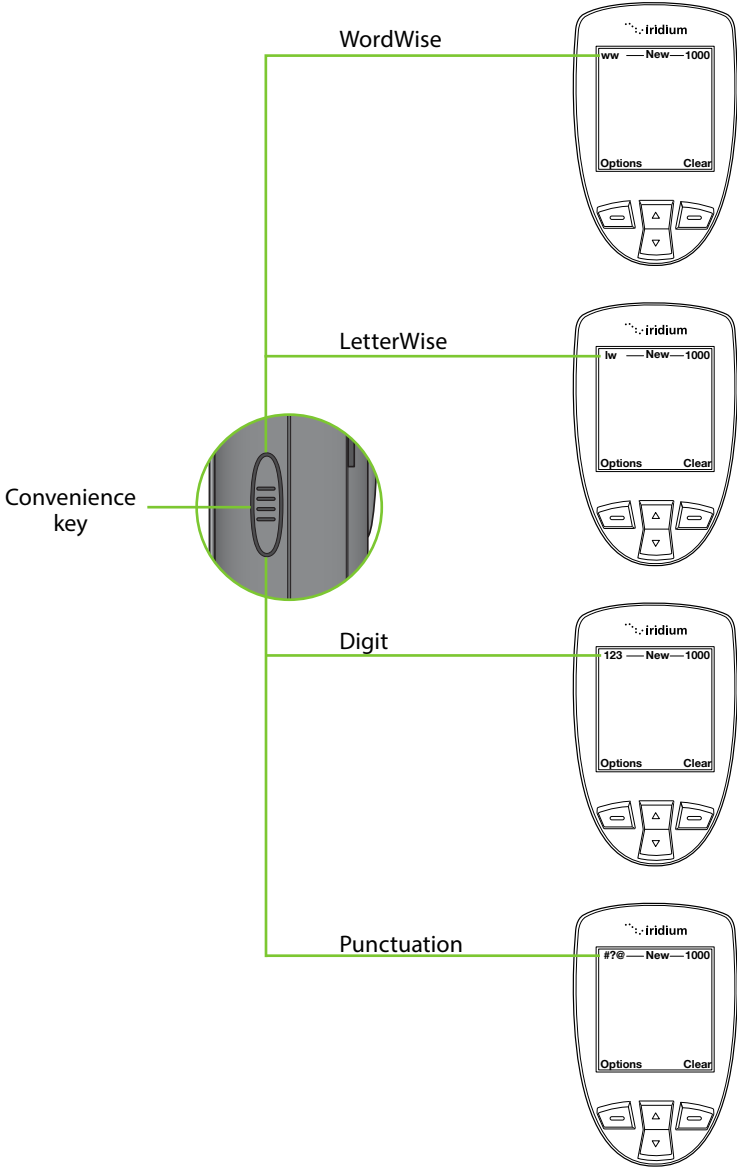

LetterWise Text mode

Press the **Convenience key** until you are in LetterWise (Lw) text mode. Press the key with the desired letter. If it doesn't appear, press the **Next key** (→) until it does. Use the **right soft key** (Clear) for backspace and **Space key** (↵) for space. Press the **Shift key** (↑) to switch between lower and upper case.

Note: Apostrophe (') for English entry and hyphen (-) for Russian entry are treated as letters (that is, can be predicted by LetterWise) and are found on **key 5**.

Example: Entering "don't."

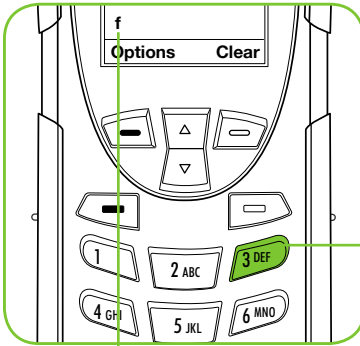

1. Press **key 3**.

Desired letter did not come up.

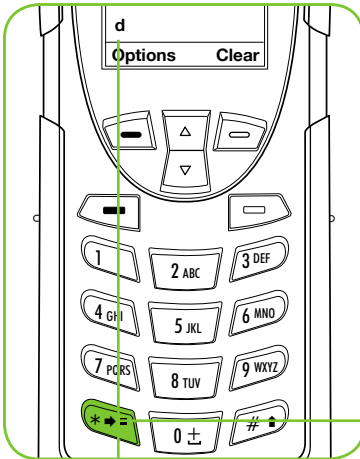

2. Press **Next key** (→) for desired letter. Proceed to next letter of the word.

Desired letter appears.

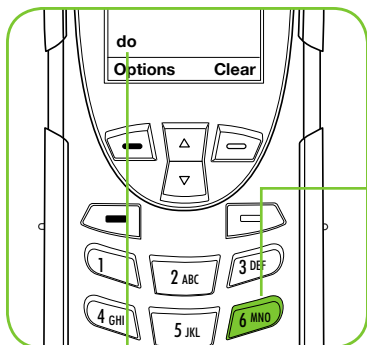

3. Press **key 6**.

Desired letter appears.

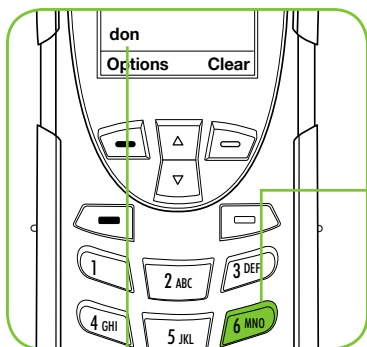

4. Press **key 6** again.

Desired letter appears.

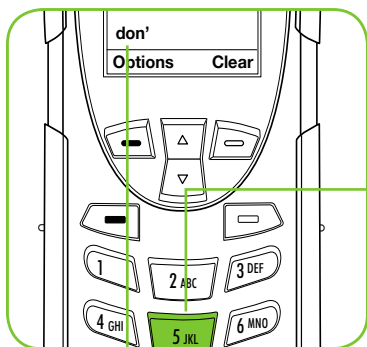

5. Press **key 5** for apostrophe.

Apostrophe is predicted along with letters in English.

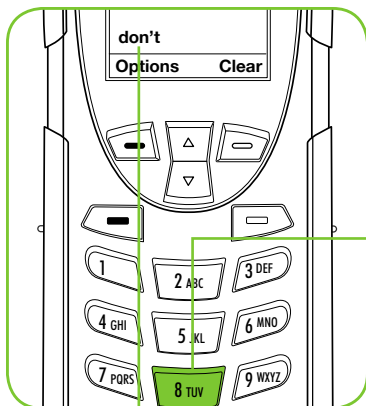

6. Press **key 8** for “t” and complete word.

Desired letter appears.

WordWise Text mode

Press the **Convenience key** until the “ww” symbol appears in the top left corner of the screen indicating that you have entered WordWise text entry mode. To enter text in WordWise, press the key containing the first letter you want to type **ONLY ONCE**.

If the correct letter does not appear at first, continue by pressing the key that corresponds to the next letter in your text, and so on.

After pressing the last key in the sequence, the word should appear. However, if the word is underlined (or highlighted), it is possible that an alternate word (which happens to require the same key presses) appeared instead. Just press Next key () until the desired word appears.

If the word you are entering is not found in any dictionary you can switch to LetterWise mode by pressing the convenience key and viewing the top left corner of the screen.

During use of WordWise, the 1 key can be used to insert punctuation without changing text entry modes. To insert punctuation, press the **1 key** and then add the appropriate punctuation by using the Next key (➡). As an alternative, you may also use the **left option key** either “Insert symbol” or “Enter digits” during WordWise use. This also applies to LetterWise use.

Example: Entering "red"

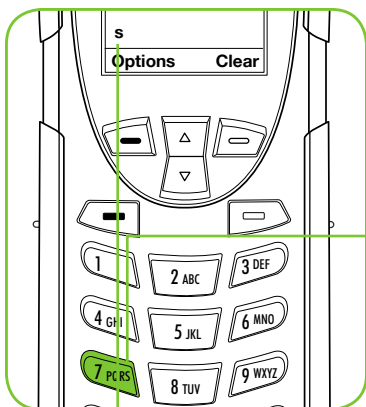

1. Press **key 7**.

Even if the correct letter "r" has not appeared, proceed with the next letter in the word.

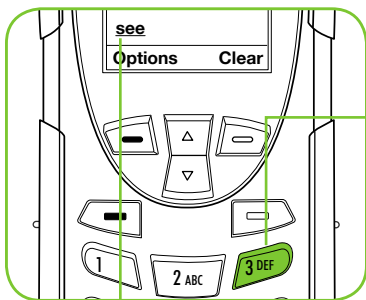

2. Press **key 3** twice for the next two letters "c & d".

The word "see" comes up which is more common than "red". The underline indicates there are other words to choose from.

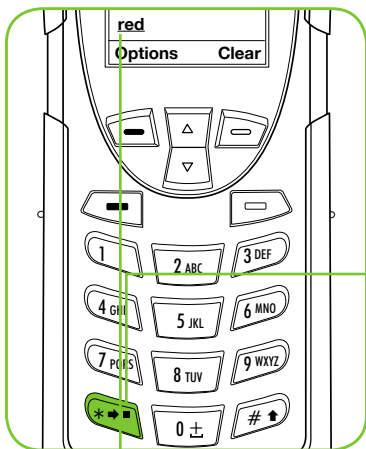

3. Press **Next Key** (→).

The word "red" appears.

Digit mode (123)

There may be times when you need to add numbers into a message that you are composing. Digit mode allows you to use the number keys to enter digits, similar to dialing a phone call. To enter digit mode, press the **Convenience key** until the **123 indicator** appears on the upper left corner of the screen. Enter the numbers required for your message and then use the **Convenience key** to return to the desired text entry mode to complete the rest of the message.

Digit mode may be entered either by pressing the **Convenience key** on the side of the phone, or with the Options menu in the **Create Message editor** to "Enter digits". During use of WordWise, the **1 key** can be used to insert punctuation without changing text entry modes.

Punctuation mode (#?@)

Punctuation mode may be entered either by pressing the **Convenience key** on the side of the phone, or with the Options menu in the **Create Message editor** to "Insert symbol". During use of WordWise, the **1 key** can be used to insert punctuation without changing text entry modes.

In Punctuation mode, symbols are spread across all keys based on their shape to help you remember which symbol is on each key (see table on following page). For example: ! is on 1 key, ? is on key 2

If there is more than one symbol on a key, press the **Next key** (➡) to get the others.

Key	English/French/Russian/Spanish*
0	. , @
1	!
2	?
3	% \$ € £
4	_ ~
5	- + = " ^
6	([{ <
7	/ \
8	:: &
9)] } >

* Spanish includes inverted versions of ! and ?.

Once you have selected the appropriate symbol for your message, you may return to your preferred text entry mode by pressing the side convenience key and viewing the top left corner of the screen.

8: Using the Phonebooks

Organizing My Phonebook

Your satellite phone has two primary phonebooks: My Phonebook and SIM Phonebook.

My Phonebook can store up to 100 names and numbers and is completely editable by you. This information is stored directly on your phone. The SIM Phonebook is provided to you by your service provider and/or organization. The entries for the SIM Phonebook are stored directly on the SIM card used with your phone and you cannot create them or edit them from your phone.

	Phone Memory	SIM Card Memory
Personal Numbers	100 entries	155 entries
Fixed Dial Numbers	No entries	40 entries
Phone Number Digits	24	20
Name Characters	24	16

Note: SIM card capacity varies depending upon the card issued by your service provider.

Locating My Phonebook

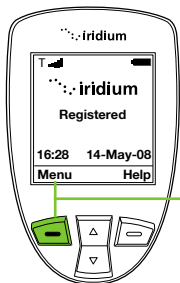

Starting from the Main Screen:

1. Press the **left soft key**, labeled **Menu**.

Note: All instructions for My Phonebook start from the **Main Menu** as shown.

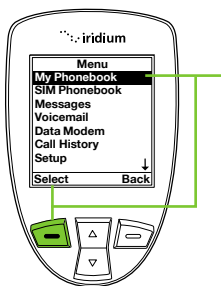

2. The **Main Menu** is now displayed, with **My Phonebook** highlighted. Press the **left soft key**, labeled **Select** to enter the **Phonebook menu**.

Note: To open the **SIM Phonebook**, use the **2-way Navi-key** to scroll until the **SIM Phonebook** is highlighted.

About the My Phonebook Menu

You can do the following functions using the **Phonebook** menu:

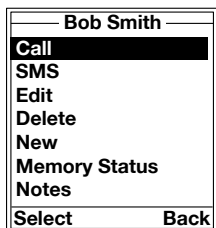

- Call an entry.
- Create and send a text message (SMS).
- Edit an entry.
- Delete an entry.
- Add an entry.
- Check the memory status of your Phonebook.
- Add notes regarding entries.

Add a New Entry to My Phonebook

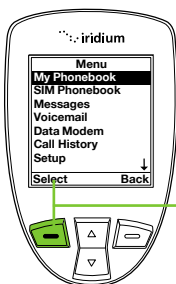

To add information to the Phonebook, use the **New** option. Start at the **Main Menu**, with **My Phonebook** highlighted:

1. Press the **left soft key**, labeled **Select**.

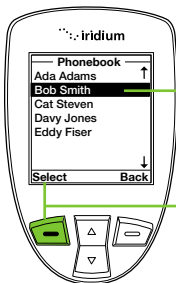

2. The **Phonebook** is displayed.

3. Press the **left soft key**, labeled **Options**.

Note: If there are no entries, Empty will be displayed on this screen. If entries are present press the **left soft key** while highlighting any contact.

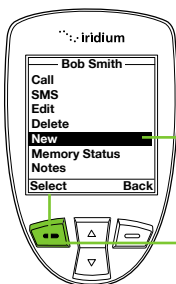

4. Use the **2-way Navi-key** until the **New** option is highlighted.

5. Press the **left soft key**, labeled **Select** to proceed.

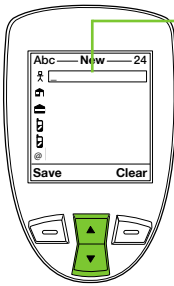

6. The **New Entry** screen is displayed with a list of icons that represent:



Name



Home phone



Work phone



1st cell phone



2nd cell phone



email address

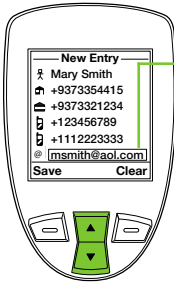

7. Use the **2-way Navi-key** to scroll to each field and the keypad to enter information into the fields.

Note: While entering or editing contact information the side volume keys allow you to move backwards and forwards without deleting.



8. Press the **left soft key**, labeled **Save**.

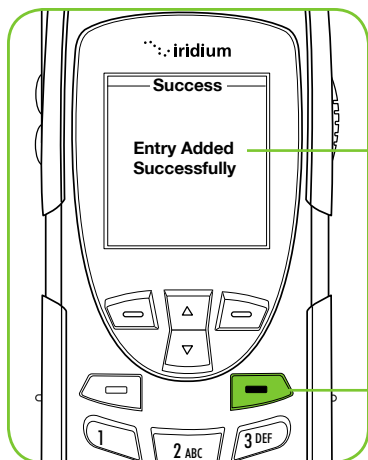

9. A message briefly appears to indicate the contact was entered successfully. The screen reverts to the main **Phonebook** menu.

Press the **red key** to return to the **Main Screen**.

Locating Entries

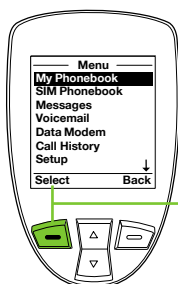

Starting at the Main Menu, using the **2-way Navi-key**, highlight the Phonebook you want to use.

1. Press the **left soft key**, labeled **Select**.

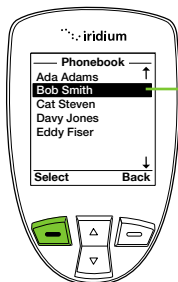

2. The **Phonebook** entries are now displayed in alphabetical order.

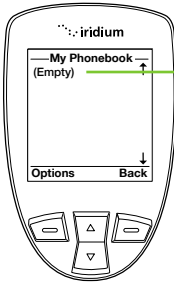

3. If there are no entries **Empty** is displayed. See “Add a New Entry to My Phonebook” on page 73.

Calling an Entry

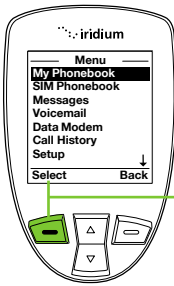

Starting at the Main Menu, using the **2-way Navi-key**, highlight the Phonebook you want to use.

1. Press the **left soft key**, labeled **Select**.

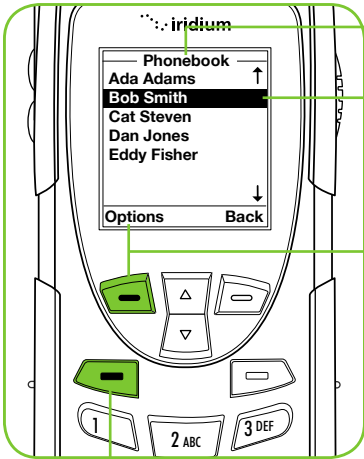

2. The **Phonebook** is displayed.

Use the **2-way Navi-key** to scroll until the desired entry is located.

3. With the entry highlighted, press the **left soft key** labeled **Options**.

Note: You can also press the green key as a short-cut to calling an entry.

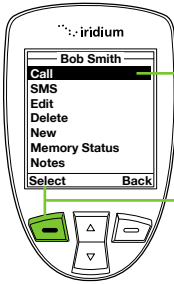

4. The **Phonebook** options are displayed.

5. With the **Call** option highlighted, press the **left soft key** labeled **Select**.

Note: If an entry has more than one number, for example, Home, Work and Mobile, then all numbers are displayed. Using the **2-way Navi-key**, highlight the number to be called and press **Select**.

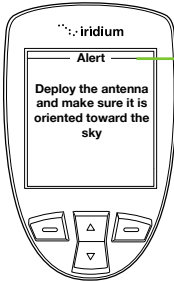

Note: If your antenna is not extended you receive an alert message telling you to extend the antenna.



6. **Calling** followed by the number you dialed is displayed. The call is then connected.

Using the Short Message Service (SMS) Menu

The Short Message Service (SMS) is a text messaging system.

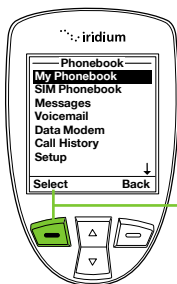

To send a text message Start at the **Main Menu**, using the **2-way Navi-key**, highlight the **Phonebook** you want to use.

1. Press the **left soft key**, labeled **Select**.

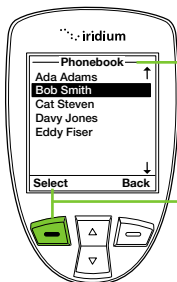

2. The **Phonebook** is displayed. Use the **2-way Navi-key** to scroll until the desired entry is located.

3. Press the **left soft key**, labeled **Options**.

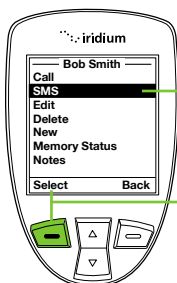

4. Use the **2-way Navi-key** until **SMS** is highlighted.

5. Press the **left soft key**, labeled **Select**.

Note: If an entry has more than one number, for example, Home, Work and Mobile, then all numbers are displayed. Using the **2-way Navi-key**, highlight the number to be called and press **Select**.

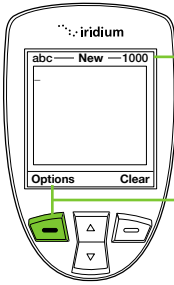

6. The **SMS** Screen now appears. You can enter up to 1,000 characters.

7. Press the **left soft key**, labeled **Options**.

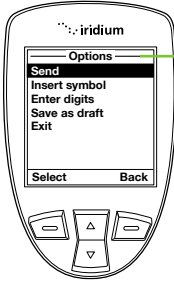

8. The **SMS Options menu** appears. From here you can:

- Send an SMS message.
- Insert symbols into your message.
- Enter digits.
- Save as a draft to send later.
- Exit the menu.

Sending an SMS Message

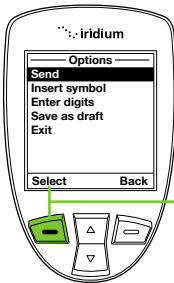

Starting at the **SMS Options Menu**:

1. While **Send** is highlighted press the **left soft key**, labeled **Select**.

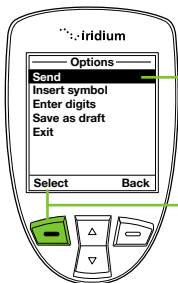

2. A **Send To** screen appears with the entry name and number.

3. Press the **left soft key**, labeled **Send**.

Note: At this time you may elect to send the message to additional recipients by highlighting **New Recipient** and pressing the **right soft key**, labeled **Add**.

Note: At this time you may elect to send the message to additional recipients by highlighting **New Recipient** and pressing the **right soft key**, labeled **Add**.

Adding an SMS Message

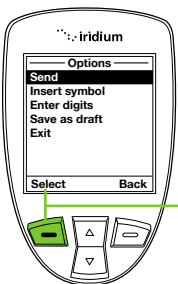

Starting at the **SMS Options** menu:

1. While **Send** is highlighted press the **left soft key**, labeled **Select**.

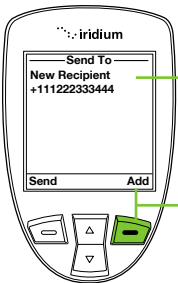

2. A **Send To** screen appears with **New Recipient** and the entry number.

3. Press the **right soft key**, labeled **Add**.

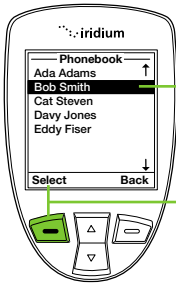

4. A list of contacts now appears. Use the **2-way Navi-key** to scroll to the desired recipient.

5. Press the **left soft key** labeled **Select**, the contact is then added to your recipient list.

Note: Repeat this procedure if you want to send the same message to more than one contact at a time.

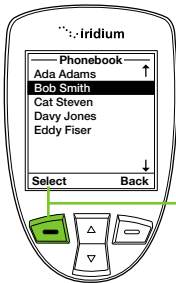

6. Once you are satisfied with the recipient(s) press **left soft key**, labeled **Send**.

Edit an Entry in My Phonebook

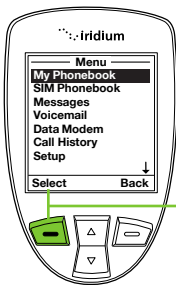

To change information in the Phonebook, use the Edit Option. Starting at the **Main Menu**, with **My Phonebook** highlighted:

1. Press the **left soft key**, labeled **Select**.

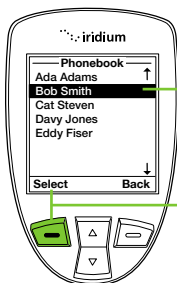

2. The Phonebook is displayed. Use the **2-way Navi-key** to scroll until the desired entry is highlighted.

3. Press the **left soft key**, labeled **Options**.

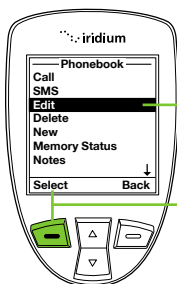

4. Use the **2-way Navi-key** until the **Edit** option is highlighted.

5. Press the **left soft key**, labeled **Select** to proceed.



6. The Edit Screen appears. Edit the entry as needed using the **2-way Navi-key** to scroll to the required field(s). Use the **side volume keys** to navigate backwards (up key) and forwards (down key) without deleting and the **right soft key**, labeled **Clear** to delete characters. Use the keypad to enter new characters.

7. Press the **left soft key**, labeled **Save**.

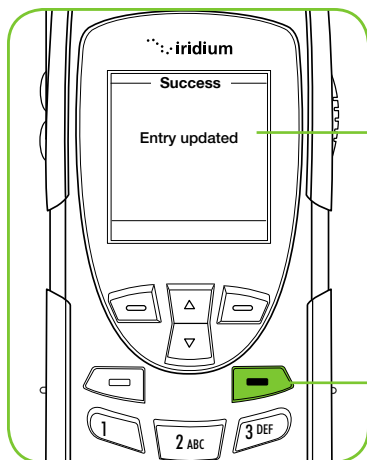

8. A message briefly appears to indicate the entry was updated. The screen then returns to the main Phonebook menu.

9. Press the **red key** to return to the **Main Screen**.

Delete an Entry

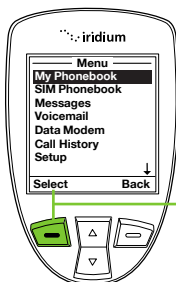

To remove an entry in the Phonebook, use the **Delete** option. Start at the **Main Menu**:

1. Press the **left soft key**, labeled **Select**.

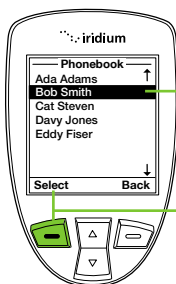

2. The Phonebook is displayed. Use the **2-way Navi-key** to scroll until the desired entry is highlighted.

3. Press the **left soft key**, labeled **Options**.

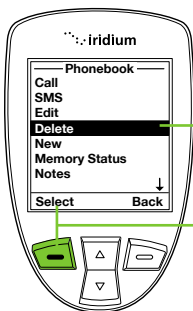

4. Use the **2-way Navi-key** until the **Delete** option is highlighted.
5. Press the **left soft key**, labeled **Select** to proceed.

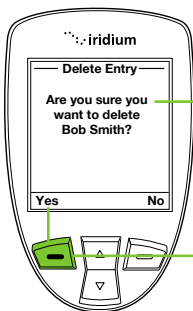

6. You receive a message asking if you want to delete the entry. Press the **left soft key**, labeled **Yes**. If you press No, the screen reverts to the previous menu.

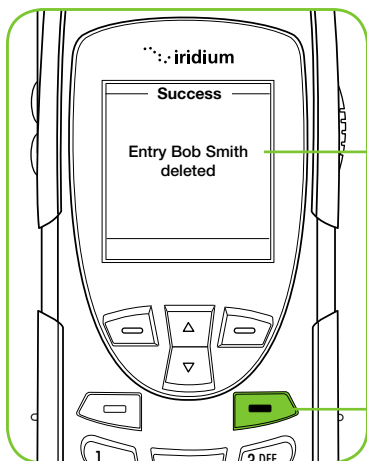

7. A message briefly appears to indicate the entry was deleted. The main Phonebook menu then appears.
8. Press the **red key** to return to the **Main Screen**.

Viewing Memory Status



Use this capability to see how many Phonebook memory locations are available in the SIM card memory and phone memory. Start at the **Main Menu**:

1. Press the **left soft key**, labeled **Select**.

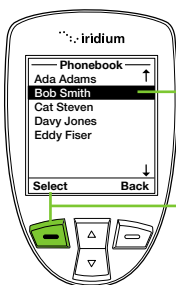

2. The Phonebook is displayed. Use the **2-way Navi-key** to scroll until the desired entry is highlighted.

3. Press the **left soft key**, labeled **Options**.

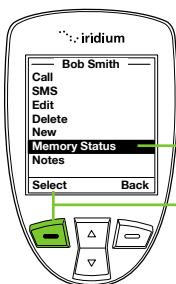

4. Use the **2-way Navi-key** until **Memory Status** is highlighted.

5. Press the **left soft key**, labeled **Select** to proceed.

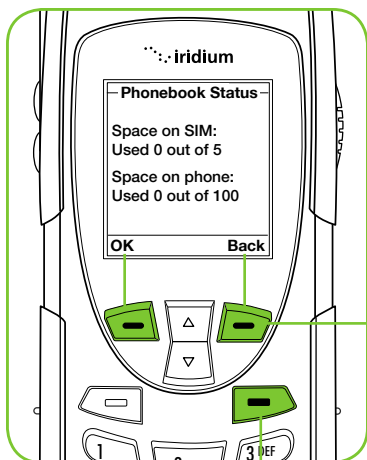

6. The **Phonebook Status** is displayed, showing the space on the SIM and the phone memory.

7. Press the **left soft key**, labeled **OK** or the **right soft key** labeled **Back** to return to the previous screen.

Press the **red key** to return to the **Main Screen**.

Adding Notes to a Phonebook Entry

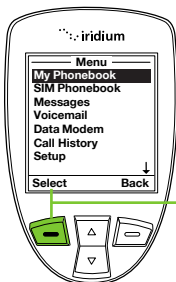

Use this capability to add information regarding an entry.

Start at the **Main Menu**:

1. Press the **left soft key**, labeled **Select**.

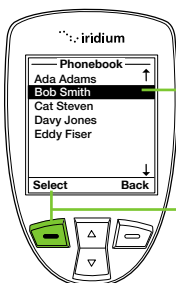

2. The Phonebook is displayed. Use the **2-way Navi-key** to scroll until the desired entry is highlighted.

3. Press the **left soft key**, labeled **Options**.

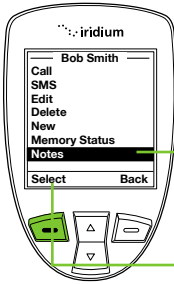

4. Use the **2-way Navi-key** until **Notes** is highlighted.

5. Press the **left soft key**, labeled **Select** to proceed.

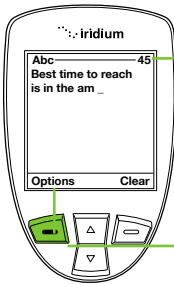

6. A text screen appears. Use the **Keypad** to enter your text.

Note: you can enter up to 64 characters. The character count in the top right corner counts down as you enter text.

7. Press the left soft key, labeled **Options**.

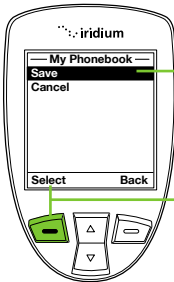

8. A My Phonebook screen appears with **Save** highlighted.

9. Press the **left soft key**, labeled **Options**.

Note: The text you entered is now stored in the Note option for this entry.

Restricted Phonebook

When the Phonebook is restricted, My Phonebook and SIM Phonebook do not appear. The main menu displays Fixed Phonebook only. The Fixed Phonebook cannot be edited.

9: Using the Messages Menu

Locating the Messages Menu

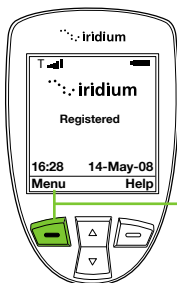

Starting from the Main Screen:

1. Press the **left soft key**, labeled **Menu**.

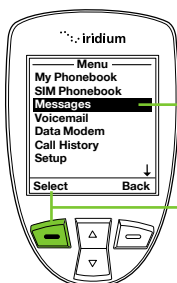

2. The **Main Menu** is displayed. Use the **2-way Navi-key** to scroll until **Messages** is highlighted.

3. Press the **left soft key**, labeled **Select**.

Note: All instructions for the **Messages** menu start from the **Main Menu** as shown.



You can perform the following functions using the Messages menu:

- Create messages.
- Read, reply, delete, call and forward messages.
- Edit stored messages and send.
- Enter service center number, set expiry period and enable or disable delivery reports.

Create and Send a new SMS Message to an Email Address not in your Phonebook

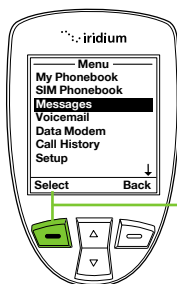

Start at the **Main Menu** with **Messages** highlighted:

1. Press the **left soft key**, labeled **Select**.

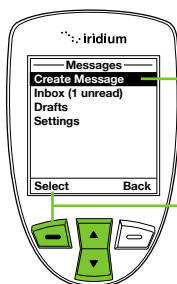

2. The **Create Message** option should be selected. If not, then use the **2-way Navi-key** to scroll until it is highlighted.
3. Press the **left soft key**, labeled **Select**.

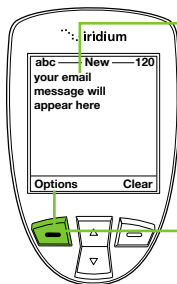

4. Enter your message.

Note: You must begin your text message with the recipients email address, leaving a space between the email address and the beginning of your message.

When your message is complete, press the **left soft key**, labeled **Options**.

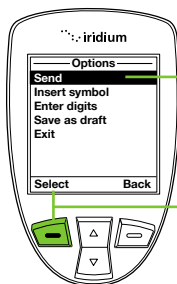

5. The **Send** option should be highlighted. If not, then use the **2-way Navi-key** to scroll until it is highlighted.
6. Press the **left soft key**, labeled **Select** to send the message.

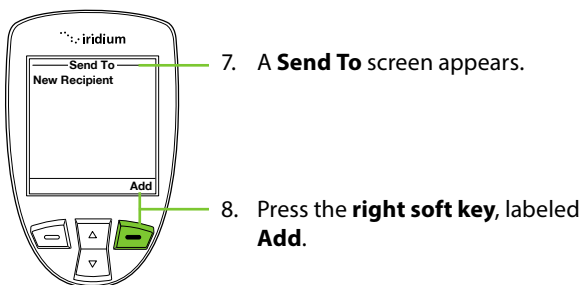

7. A **Send To** screen appears.

8. Press the **right soft key**, labeled **Add**.

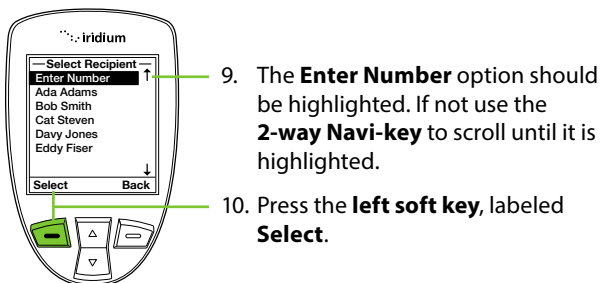

9. The **Enter Number** option should be highlighted. If not use the **2-way Navi-key** to scroll until it is highlighted.

10. Press the **left soft key**, labeled **Select**.

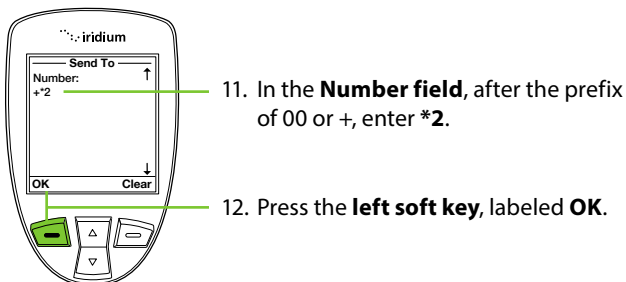

11. In the **Number field**, after the prefix of 00 or +, enter *2.

12. Press the **left soft key**, labeled **OK**.

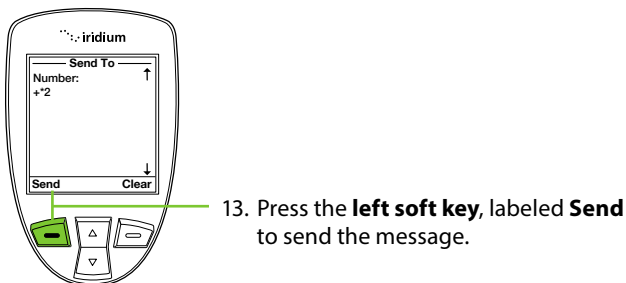

13. Press the **left soft key**, labeled **Send** to send the message.

Create and Send a new SMS Message to an Email Address in My Phonebook

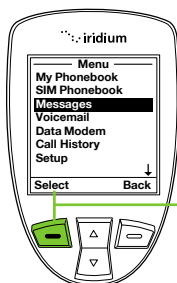

Start at the **Main Menu** with **Messages** highlighted:

1. Press the **left soft key**, labeled **Select**.

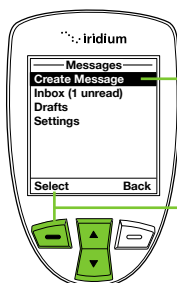

2. The **Create Message** option should be selected. If not, then use the **2-way Navi-key** to scroll until it is highlighted.
3. Press the **left soft key**, labeled **Select**.

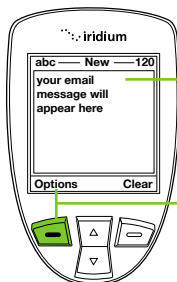

4. Enter your message.
5. When your message is complete, press the **left soft key**, labeled **Options**.

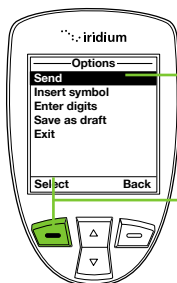

6. The **Send** option should be highlighted. If not, then use the **2-way Navi-key** to scroll until it is highlighted.
7. Press the **left soft key**, labeled **Select** to send the message.

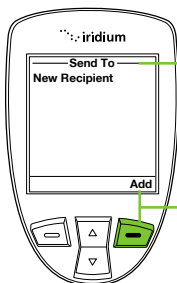

8. A **Send To** screen appears.

9. Press the **right soft key**, labeled **Add**.

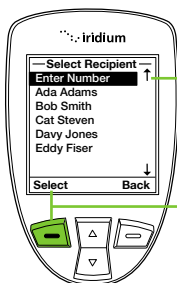

10. Use the **2-way Navi-key** to highlight your selection.

11. Press the **left soft key**, labeled **Select**.

Note: If the Contact's email address is the only information listed, the screen returns you to the **Send To** screen.



12. If the Contact has an email address as well as a phone number listed, you are presented with their phonebook entry. Use the **2-way Navi-key** to highlight their email address and press the **left soft key**, labeled **Select**.

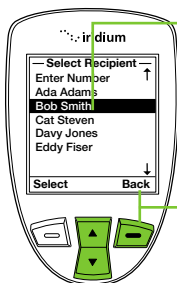

13. The **Phonebook** screen appears with the recipient's name highlighted. To add another recipient, use the **2-way Navi-key** to highlight the next recipient and repeat step 10.

14. Once all recipients have been selected, press the **right soft key**, labeled **Back**.

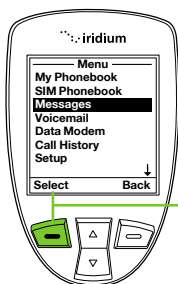

15. Press the **left soft key**, labeled **Send**.

About SMS Messaging

Message Notification

If your phone is powered ON, it notifies you of received messages in the following ways:

- An alert sounds and/or the phone vibrates.
- The message indicator is displayed.
- The message **New Message. Read Now?** is displayed.

How Messages are Stored

Your phone stores all messages on the SIM card. If the message indicator is flashing, your SIM card is full. See “Delete a Message” on page 100 to make room for the new message.

What Messages Contain

You can receive short text or numeric messages in your Personal Mailbox. Text messages may contain up to 1,000 characters. Numeric messages, typically phone numbers, may contain up to 20 digits.

Standard SMS messages are up to 160 characters. Long SMS messages up to 1000 characters are divided into smaller 160 character messages and may be billed at the standard 160 character SMS rate. For example, an SMS message with 320 characters may be billed as two standard SMS messages. Contact your service provider for additional information.

Your personal mailbox works with Call Forwarding. For more information see “Forward a Received Message” on page 97.

Using the Inbox

You can do the following functions using the **Inbox**:

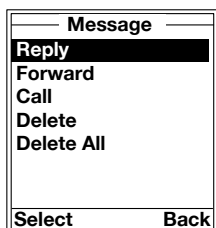

- Reply to a message.
- Forward a message.
- Call the number that left the message.
- Delete one or all messages.

Note: If the message storage space on your SIM card is full, you cannot store a message for later retrieval. See “Delete a Message” on page 100 to make room for new messages on your SIM card.

Read a Message

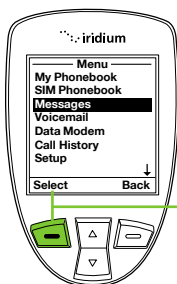

Start at the **Main Menu** with **Messages** highlighted:

1. Press the **left soft key**, labeled **Select**.

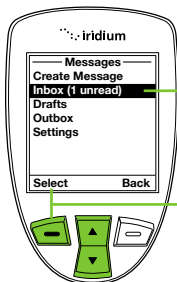

2. Use the **2-way Navi-key** to scroll until **Inbox** is highlighted.

3. Press the **left soft key**, labeled **Select**.

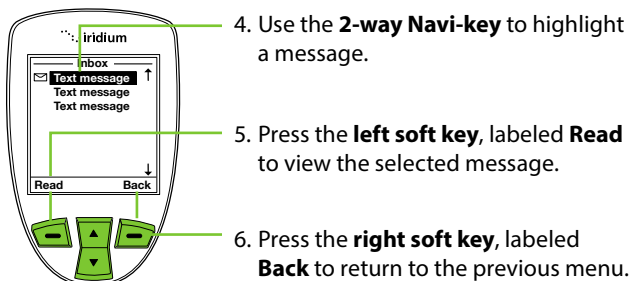

Reply to Sender

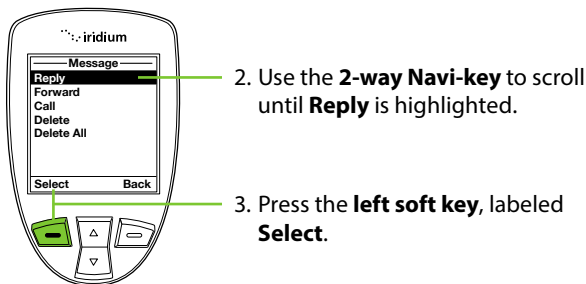
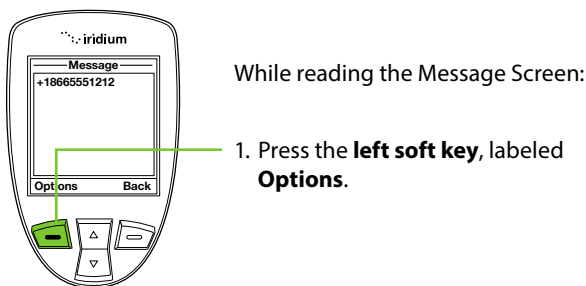

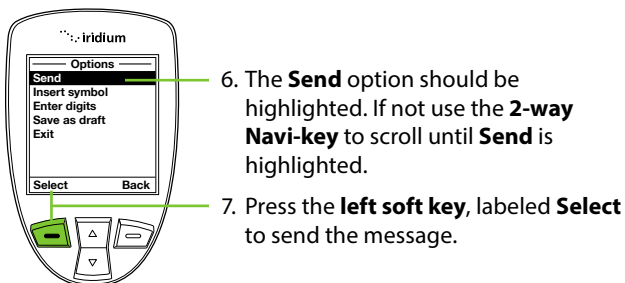
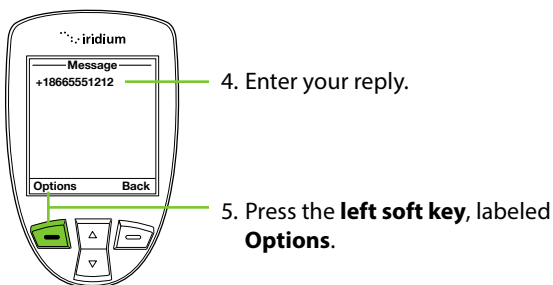

Note: If the sender's phone number is not part of your phonebook, select New Recipient to add the number.

Forward a Received Message

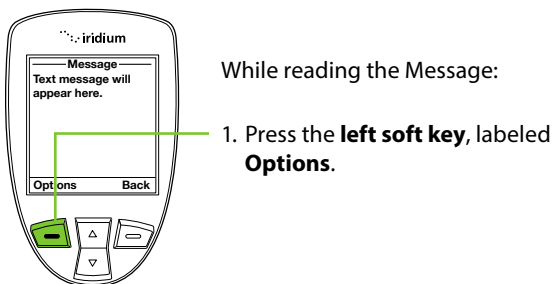

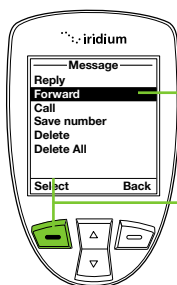

2. Use the **2-way Navi-key** to scroll until **Forward** is highlighted.

3. Press the **left soft key**, labeled **Select**.

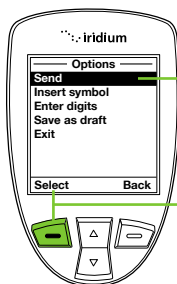

4. The **Send** option should be highlighted. If not use the **2-way Navi-key** to scroll until **Send** is highlighted.

5. Press the **left soft key**, labeled **Select** to send the message.

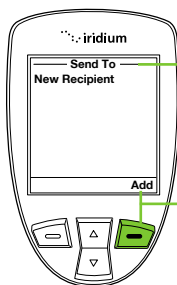

6. A **Send To** screen appears.

7. Press the **right soft key**, labeled **Add**.

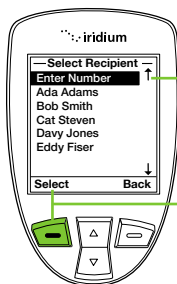

8. Use the **2-way Navi-key** until the desired recipient from your phonebook is highlighted.

9. Press the **left soft key**, labeled **Options**.



10. If the recipient has more than one number listed, the recipient's information screen appears. Use the **2-way Navi-key** to scroll to the number you would like to forward to.
11. Press the **left soft key**, labeled **Select**. The number is added to a recipient list.

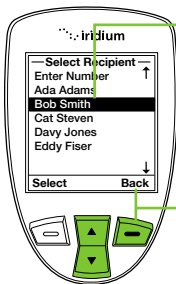

12. The **Phonebook** screen appears with the recipient's name highlighted. To add another recipient, use the **2-way Navi-key**, highlight the next recipient and repeat step 8.
13. Once all recipients have been selected, press the **right soft key**, labeled **Back**.

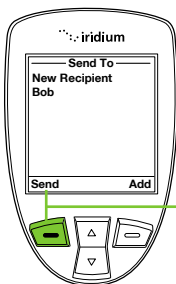

14. Press the **left soft key**, labeled **Send**.

Call a Number from a Received Message

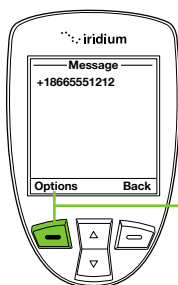

While reading the Message Screen:

1. Press the **left soft key**, labeled **Options**.

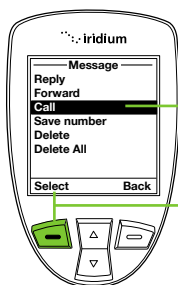

2. Use the **2-way Navi-key** to scroll until **Call** is highlighted.
3. Press the **left soft key**, labeled **Select**.

Delete a Message

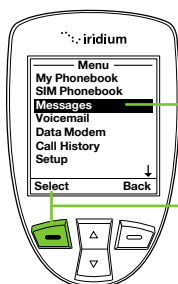

Start at the **Main Menu** with **Messages** highlighted:

1. Press the **left soft key**, labeled **Select**.

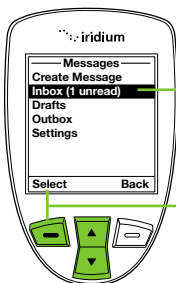

2. Use the **2-way Navi-key** to scroll until **Inbox** is highlighted.

3. Press the **left soft key**, labeled **Select**.

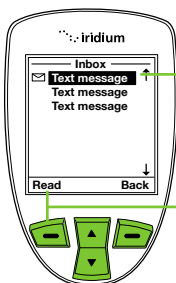

4. Use the **2-way Navi-key** to scroll to the message.

5. Press the **left soft key**, labeled **Read** to view the selected message.

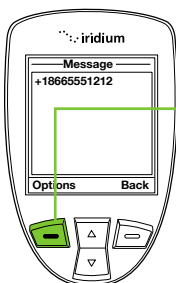

6. Press the **left soft key**, labeled **Options**.

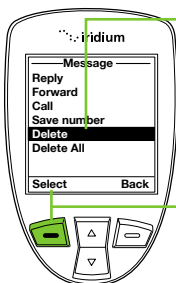

7. Use the **2-way Navi-key** to scroll until **Delete** is highlighted. To delete all messages highlight **Delete All**.

8. Press the **left soft key**, labeled **Select**.

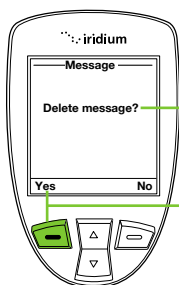

9. The Satellite Phone prompts you to ensure you want to proceed. Press the **left soft key**, labeled **Yes** to delete the message.

The screen flashes **Message Deleted**, and automatically returns to the Message mailbox.

Using the Drafts Menu

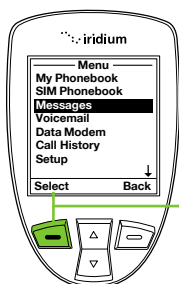

To edit and send a stored message, use the **Draft menu**. Start at the **Main Menu** with **Messages** highlighted:

1. Press the **left soft key**, labeled **Select**.

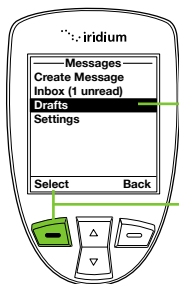

2. Use the **2-way Navi-key** to scroll until the **Drafts** option is highlighted.
3. Press the **left soft key**, labeled **Select**.

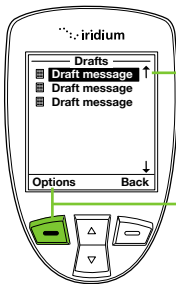

4. Use the **2-way Navi-key** to scroll until the draft message you want to send is highlighted.

5. Press the **left soft key**, labeled **Options**.

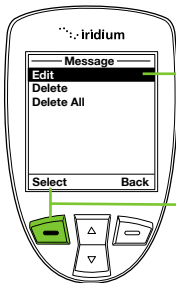

6. Highlight **Edit** and press the **left soft key**, labeled **Select**.

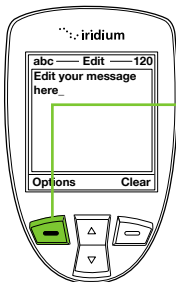

7. When you are finished editing press the **left soft key**, labeled **Options**.

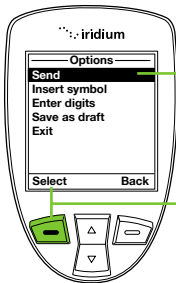

8. The **Send** option should be highlighted. If not use the **2-way Navi-key** to scroll until **Send** is highlighted.

9. Press the **left soft key**, labeled **Select** to send the message.

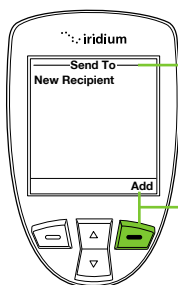

10. A **Send To** screen appears with the entry name and number.

11. Press the **right soft key**, labeled **Add**.

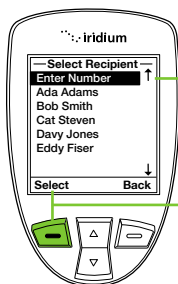

12. Use the **2-way Navi-key** until the desired recipient from your phonebook is highlighted.

13. Press the **left soft key**, labeled **Select**.



14. If the recipient has more than one number listed, the recipient's information screen appears. Use the **2-way Navi-key** to scroll to the number you would like to forward to.

15. Press the **left soft key**, labeled **Select**. The number is added to a recipient list.

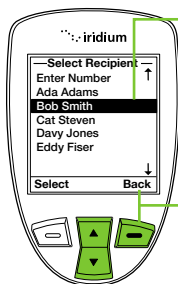

16. The **Phonebook** screen appears with the recipient's name highlighted. To add another recipient, use the **2-way Navi-key**, highlight the next recipient and repeat step 12.

17. Once all recipients have been selected, press the **right soft key**, labeled **Back**.

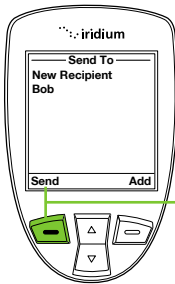

18. Press the **left soft key**, labeled **Send**.

Using the Settings Menu

Enter Service Center Number

Use this capability to enter the number for the service center to which you wish to forward your outgoing messages. The Iridium 9555 Satellite Phone will use Iridium's Service Center number by default if none has been explicitly configured.

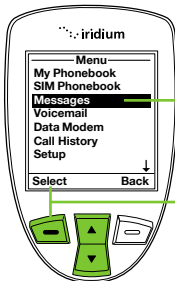

- Start at the **Main Menu** with **Messages** highlighted:

1. Press the **left soft key**, labeled **Select**.

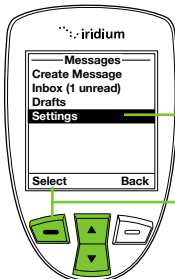

2. Use the **2-way Navi-key** to scroll until the **Settings** option is highlighted.

3. Press the **left soft key**, labeled **Select**.

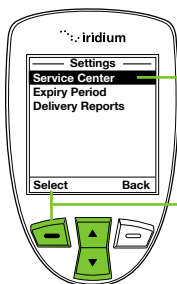

4. The **Service Center** option should be highlighted. If not use the **2-way Navi-key** to scroll until it is highlighted.

5. Press the **left soft key**, labeled **Select**.

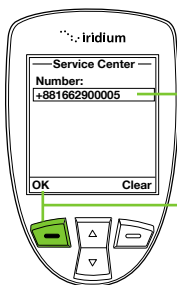

6. Enter the service number.

7. Press the **left soft key**, labeled **OK**. The screen returns to the **Settings** menu.

Set Expiry Period

Use this capability to specify the amount of time your undelivered messages should wait before auto-expiring.

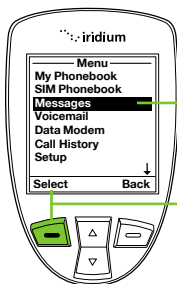

Start at the **Main Menu** with **Messages** highlighted:

1. Press the **left soft key**, labeled **Select**.

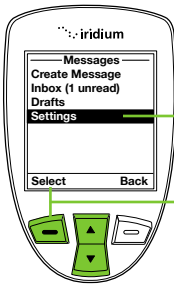

2. Use the **2-way Navi-key** to scroll until the **Settings** option is highlighted.

3. Press the **left soft key**, labeled **Select**.

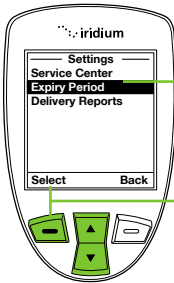

4. Use the **2-way Navi-key** to scroll until the **Expiry Period** option is highlighted.

5. Press the **left soft key**, labeled **Select**.

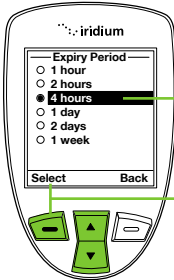

6. Use the **2-way Navi-key** to scroll until the desired period of time is highlighted.

7. Press the **left soft key**, labeled **Select**. The screen returns to the **Settings** menu.

Select Delivery Reports

Use this capability to enable or disable message delivery reports.

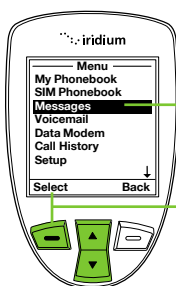

Start at the **Main Menu** with **Messages** highlighted:

1. Press the **left soft key**, labeled **Select**.

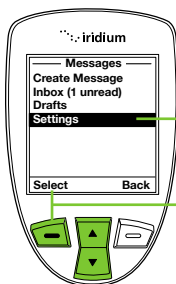

2. Use the **2-way Navi-key** to scroll until the **Settings** option is highlighted.

3. Press the **left soft key**, labeled **Select**.

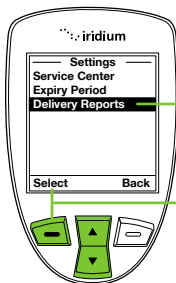

4. Use the **2-way Navi-key** to scroll until the **Delivery Reports** option is highlighted.

5. Press the **left soft key**, labeled **Select**.

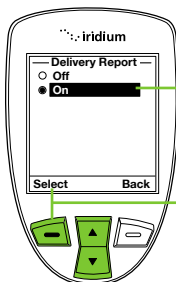

6. Use the **2-way Navi-key** to turn the **Delivery Report OFF** or **ON**.

7. Press the **left soft key**, labeled **Select**. The screen returns to the **Settings** menu.

10: Using the Voicemail Menu

Locating the Voicemail Menu

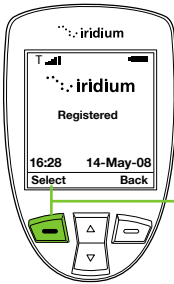

Starting from the **Main Screen**:

1. Press the **left soft key**, labeled **Menu**.

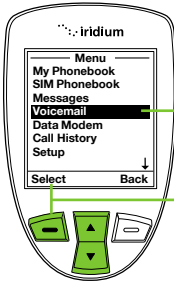

2. The **Main Menu** is displayed. Use the **2-way Navi-key** to scroll until the **Voicemail** is highlighted.

3. Press the **left soft key**, labeled **Select**.

Note: All instructions for the **Voicemail** menu start from the **Main Menu** as shown.

About the Voicemail Menu

You can do the following functions using the **Voicemail** menu:

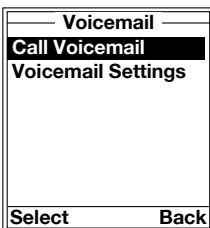

- Listen to your voicemail.
- Reply to a voicemail.
- Store voicemail numbers.
- Access and configure your voicemail.

Vicemail Notification

When you receive a voicemail, an incoming voicemail notification message automatically appears on your screen.

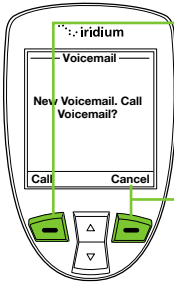

Press the **left soft key**, labeled **Call** to call and retrieve voicemail.

OR

Press the **right soft key**, labeled **Cancel**.

Check Your Voicemail

To listen to a voicemail that has been saved:

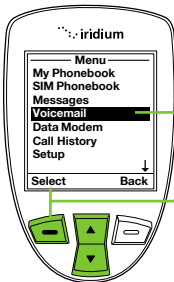

1. Use the **2-way Navi-key** to scroll until the **Voicemail** is highlighted.

2. Press the **left soft key**, labeled **Select**.

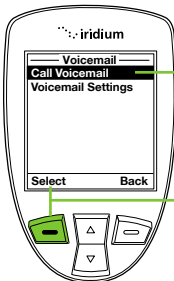

3. **Call Voicemail** is highlighted.

4. Press the **left soft key**, labeled **Select**.

Follow the audio prompts for additional capabilities.

Store Your Voicemail Number

If you have not previously stored a voicemail number, then you see No Number Available on the display. You must store a voicemail number before you can access the service for the first time.

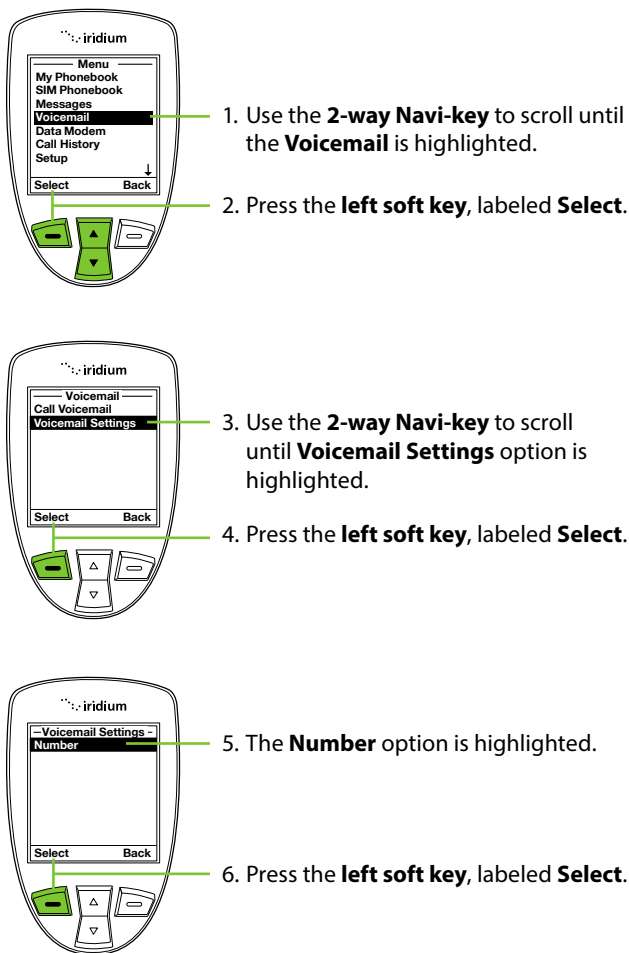

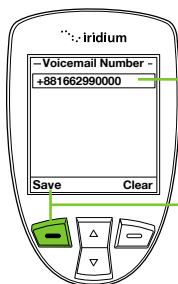

7. Enter the voicemail number given to you by your Service Provider.
8. Press the **left soft key**, labeled **Save**.

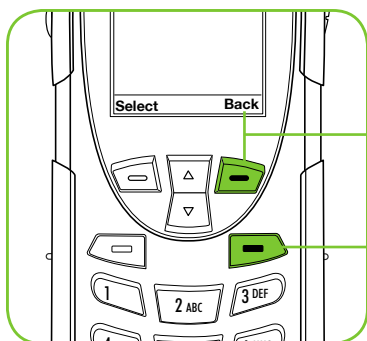

9. Press the **right soft key**, labeled **Back** to return to the previous menu.
10. Press the **red key** to exit to the **Main Screen**.

One-Touch Access to Voicemail

With the most recent software available to the Iridium 9555 Satellite Phone, Iridium enabled one-touch access to voicemail for ease of use. To use this new feature, ensure that you have the most recent software and press and hold the 1 key for 2 seconds in order to prompt a call to voicemail without having to navigate through the phone menu.

11: Using the Data Modem Menu

In order to use the Iridium 9555 Satellite Phone as a modem for your computer, you must first follow the installation instructions provided on the CD-ROM included with your phone or use the instructions provided by your service provider. The data modem menu is not required to initiate or use the phone as a modem for data services, it only reports the connection status of the USB. The instructions provided are optional and are to be followed if desired prior to plugging in the USB cable to the phone and to your computer.

Locating the Data Modem Menu

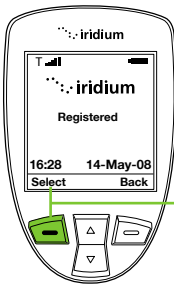

Starting from the **Main Screen**:

1. Press the **left soft key**, labeled **Menu**.

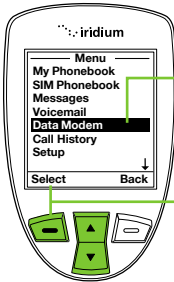

2. The **Main Menu** is displayed. Use the **2-way Navi-key** to scroll until **Data Modem** is highlighted.

3. Press the **left soft key**, labeled **Select**.

Note: All instructions for the **Data Modem** menu start from the **Main Menu** as shown.

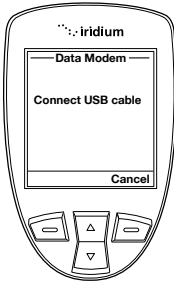

Note: If you are not connected to the USB cable you are prompted to connect. While connected to the USB cable it is important to not remove the battery.

If you need to remove the battery, first disconnect from the USB cable, power down the Iridium 9555 Satellite Phone and then remove the battery.

12: Using the Call History Menu

Locating the Call History Menu

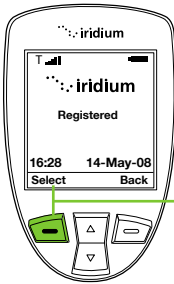

Starting from the **Main Screen**:

1. Press the **left soft key**, labeled **Menu**.

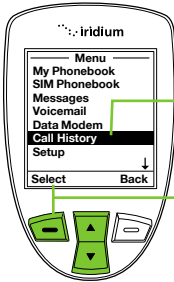

2. The **Main Menu** is displayed. Use the **2-way Navi-key** to scroll until **Call History** is highlighted.

3. Press the **left soft key**, labeled **Select**.

Note: All instructions for the **Call History** menu start from the **Main Menu** as shown.

About the Call History Menu

You can perform the following functions using the **Call History** menu:

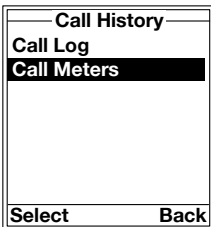

- View the amount of time spent talking on your phone.
- View your most recent dialed, missed and received calls.
- Set phone alerts.

Using the Call Log Menu

View Most Recent Received Calls

Your phone saves received calls. Use the **Call Log** menu to view those numbers.

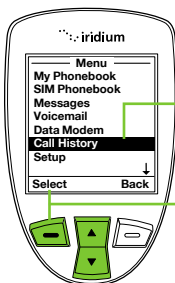

Starting from the **Main Menu**:

1. Use the **2-way Navi-key** to scroll until **Call History** is highlighted.
2. Press the **left soft key**, labeled **Select**.

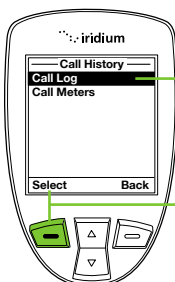

3. The **Call History** menu is displayed with **Call Log** highlighted.
4. Press the **left soft key**, labeled **Select**.

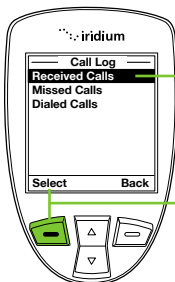

5. The **Call Log** menu is displayed with **Received Calls** highlighted.
6. Press the **left soft key**, labeled **Select**.

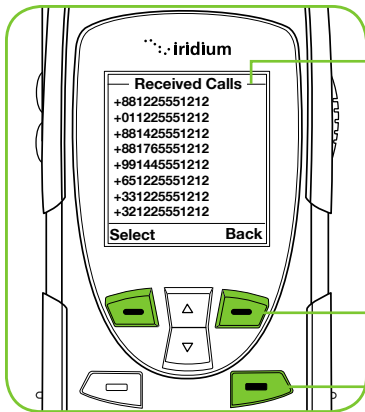

7. The **Received Calls** screen is displayed with a list of your last ten calls. Inbound Caller ID to provide specific numbers is not currently supported by the network. This feature may be enabled in the future.

Press the **right soft key** labeled **Back** to go back one level, or the **red key** to return the **Main Screen**.

View Missed Calls

Your phone saves a list of calls you've missed when the phone is busy or were not able to get to it. The phone does not show calls that you missed when the phone is turned OFF or not registered on the network.

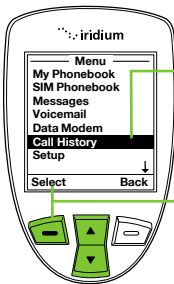

Starting from the **Main Menu**:

1. Use the **2-way Navi-key** to scroll until **Call History** is highlighted.

2. Press the **left soft key**, labeled **Select**.

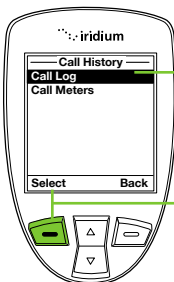

3. The **Call History** menu is displayed with **Call Log** highlighted.

4. Press the **left soft key**, labeled **Select**.

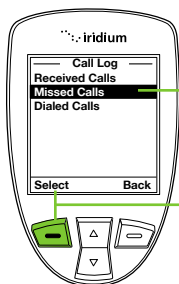

- Using the **2-way Navi-key** scroll until **Missed Calls** is highlighted.
- Press the **left soft key**, labeled **Select**.

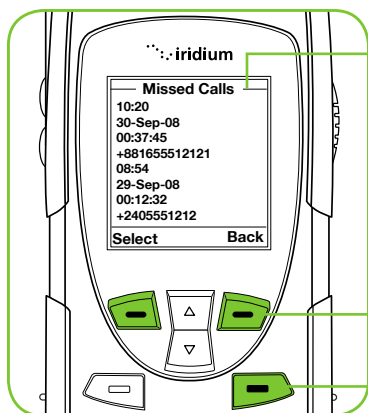

- The **Missed Calls** screen is displayed with a list of your last missed calls. Inbound Caller ID to provide specific numbers is not currently supported by the network. This feature may be enabled in the future
- Press the **right soft key** labeled **Back** to go back one level, or the **red key** to return the **Main Screen**.

View Most Recent Dialed Calls

Your phone saves the last ten calls dialed. Use the Call Log menu to view those numbers.

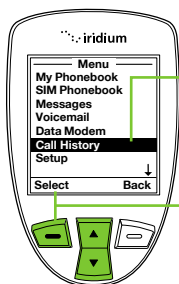

- Starting from the **Main Menu**:
- Use the **2-way Navi-key** to scroll until **Call History** is highlighted.
 - Press the **left soft key**, labeled **Select**.

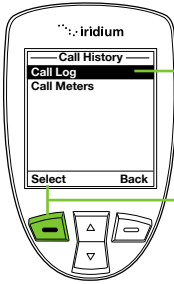

3. The **Call History** menu is displayed with **Call Log** highlighted.

4. Press the **left soft key**, labeled **Select**.

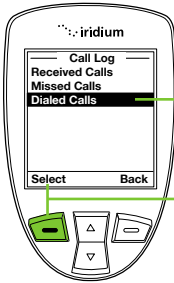

5. Using the **2-way Navi-key** scroll until **Dial Meters** is highlighted.

6. Press the **left soft key**, labeled **Select**.

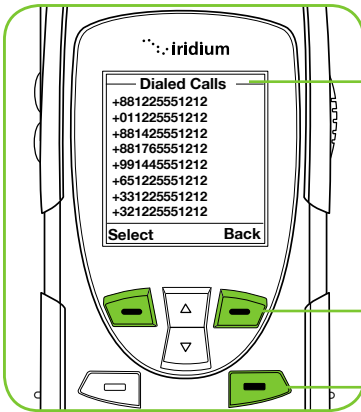

7. The **Dial Meters** screen is displayed with a list of your last ten calls.

Press the **right soft key** labeled **Back** to go back one level, or the **red key** to return the **Main Screen**.

Using the Call Meters Menu

Call meters help you track your airtime, keep a running tab of your monthly usage or view the air time of your most recent calls.

Show the Time of Last Call

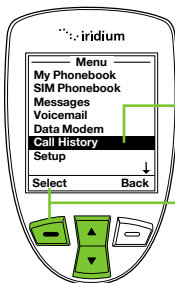

Starting from the **Main Menu**:

1. Use the **2-way Navi-key** to scroll until **Call History** is highlighted.
2. Press the **left soft key**, labeled **Select**.

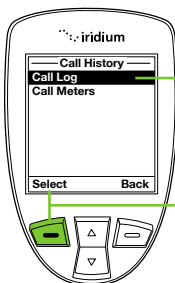

3. Use the **2-way Navi-key** to scroll until **Call Meters** is highlighted.
4. Press the **left soft key**, labeled **Select**.

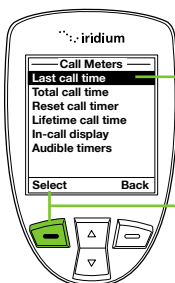

5. **Last call time** is highlighted. If not, use the **2-way Navi-key** until it is.
6. Press the **left soft key**, labeled **Select**.

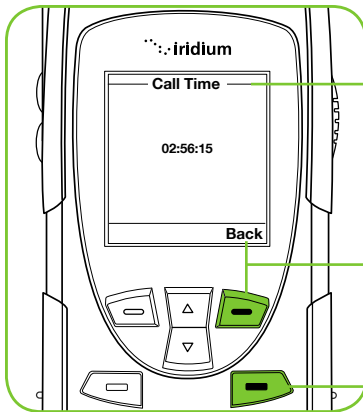

The duration of the last call is displayed.

7. Press the **right soft key** labeled **Back** to return to the previous menu.

8. Press the **red key** to return to the **Main Screen**.

Note: The last call timer shows the elapsed time of the most recent call made since your phone was turned on. This information is not saved when you turn off the phone.

Show Total Time for All Calls

This capability displays your total airtime since you last reset the call timer.

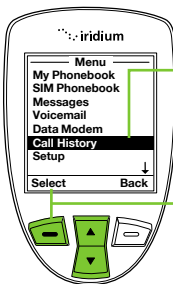

Starting from the **Main Menu**:

1. Use the **2-way Navi-key** to scroll until **Call History** is highlighted.

2. Press the **left soft key**, labeled **Select**.

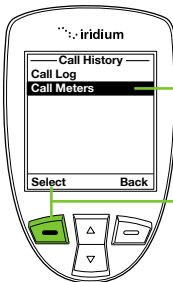

3. Use the **2-way Navi-key** to scroll until **Call Meters** is highlighted.

4. Press the **left soft key**, labeled **Select**.

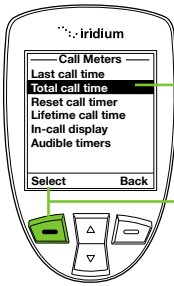

5. Use the **2-way Navi-key** to scroll until **Total call time** is highlighted.
6. Press the **left soft key**, labeled **Select**.

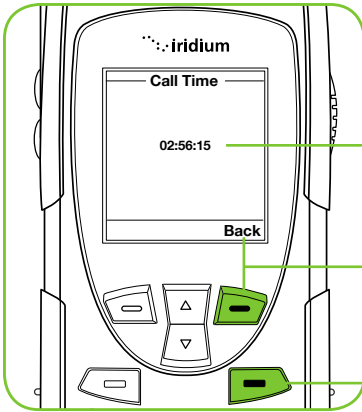

- The airtime accumulation since the timer was last reset is displayed on the screen.
7. Press the **right soft key** labeled **Back** to return to the previous menu.
8. Press the **red key** to return to the **Main Screen**.

Reset all Timers

Reset your timers at the beginning of each billing cycle to keep track of your spending.

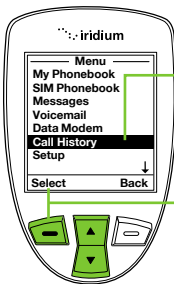

- Starting from the **Main Menu**:
1. Use the **2-way Navi-key** to scroll until **Call History** is highlighted.
 2. Press the **left soft key**, labeled **Select**.

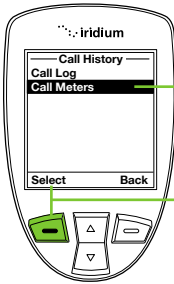

3. Use the **2-way Navi-key** to scroll until **Call Meters** is highlighted.

4. Press the **left soft key**, labeled **Select**.

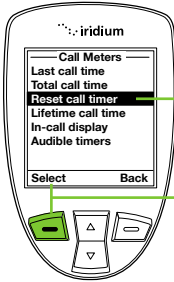

5. Use the **2-way Navi-key** to scroll until **Reset call timer** is highlighted.

6. Press the **left soft key**, labeled **Select**.

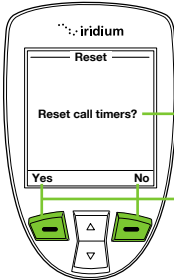

The screen displays: **Reset call timers?**

7. Press the **left soft key** for **Yes** or the **right soft key** for **No**.

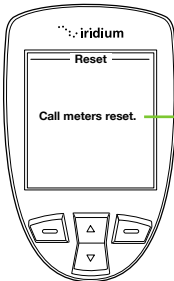

8. If you press **Yes**, the display reads **Call meters reset**.

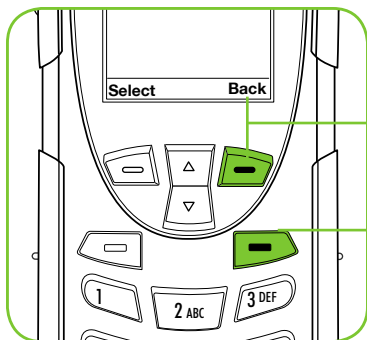

9. Press the **right soft key** labeled **Back** to return to the previous menu.
10. Press the **red key** to return to the **Main Screen**.

Showing the Lifetime Call Timer

This capability displays a running clock of the total call time for the phone since being activated.

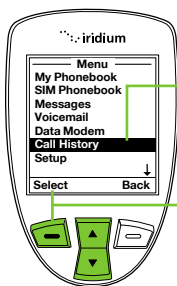

Starting from the **Main Menu**:

1. Use the **2-way Navi-key** to scroll until **Call History** is highlighted.
2. Press the **left soft key**, labeled **Select**.

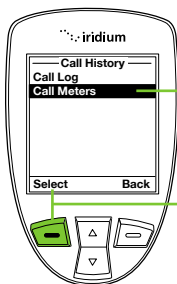

3. Use the **2-way Navi-key** to scroll until **Call Meters** is highlighted.
4. Press the **left soft key**, labeled **Select**.

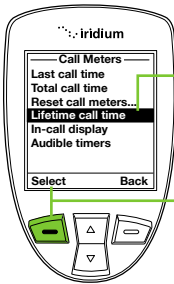

3. Use the **2-way Navi-key** to scroll until **Call Meters** is highlighted.
4. Press the **left soft key**, labeled **Select**.

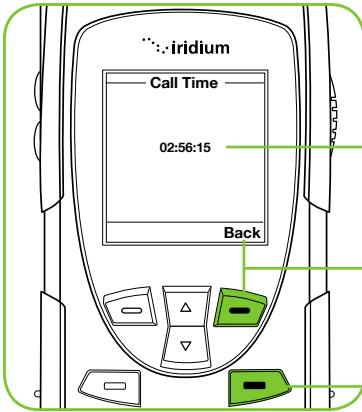

- The total time of all calls is displayed.
7. Press the **right soft key** labeled **Back** to return to the previous menu.
8. Press the **red key** to return to the **Main Screen**.

Note: The Lifetime timer can not be reset.

Showing the In-call Display

This capability enables or disables the call timer that displays the amount of time that has passed since placing a specific call.

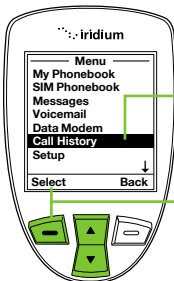

- Starting from the **Main Menu**:
1. Use the **2-way Navi-key** to scroll until **Call History** is highlighted.
 2. Press the **left soft key**, labeled **Select**.

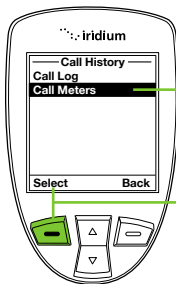

3. Use the **2-way Navi-key** to scroll until **Call Meters** is highlighted.

4. Press the **left soft key**, labeled **Select**.

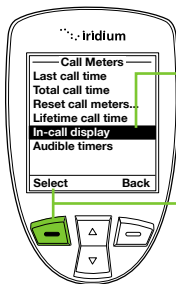

5. Use the **2-way Navi-key** to scroll until **In-call display** is highlighted.

6. Press the **left soft key**, labeled **Select**.

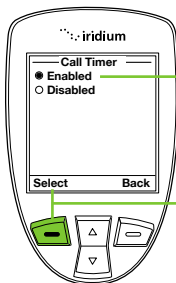

7. Use the **2-way Navi-key** to scroll to **Enabled** or **Disabled**.

8. Press the **left soft key**, labeled **Select**.

Setting Audible Call Timers

This capability lets the phone watch the clock for you. At a set time or interval, the call timers produce a beep that only you can hear. You can choose No Alert, Single Alert or Repetitive Alert.

Set the Single Alert Timer

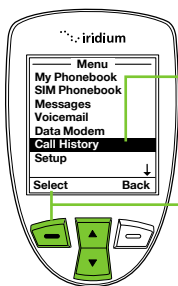

Starting from the **Main Menu**:

1. Use the **2-way Navi-key** to scroll until **Call History** is highlighted.

2. Press the **left soft key**, labeled **Select**.

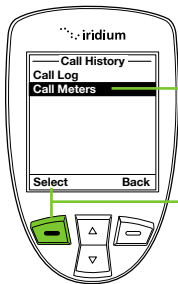

3. Use the **2-way Navi-key** to scroll until **Call Meters** is highlighted.

4. Press the **left soft key**, labeled **Select**.

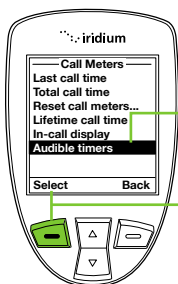

5. Use the **2-way Navi-key** to scroll until **Audible timers** is highlighted.

6. Press the **left soft key**, labeled **Select**.

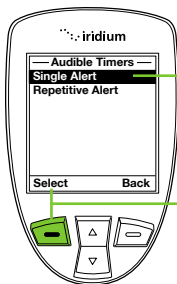

7. The **Single Alert** option should be highlighted. If not, use the **2-way Navi-key** to scroll until it is.
8. Press the **left soft key**, labeled **Select**.

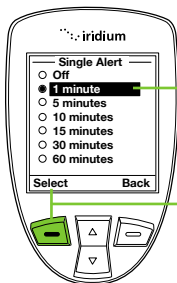

9. Use the **2-way Navi-key** to scroll to the desired single alert.
10. Press the **left soft key**, labeled **Select**.

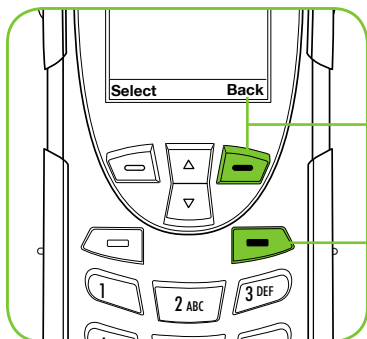

11. Press the **right soft key** labeled **Back** to return to the previous menu.
12. Press the **red key** to return to the **Main Screen**.

Set the Repetitive Alert

This capability sets your phone to alert you at specific intervals, for example every minute.

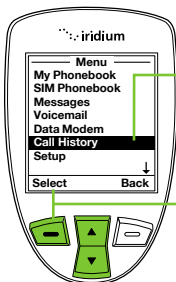

Starting from the **Main Menu**:

1. Use the **2-way Navi-key** to scroll until **Call History** is highlighted.

2. Press the **left soft key**, labeled **Select**.

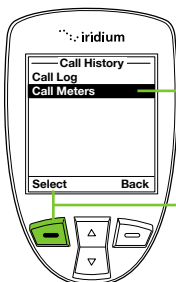

3. Use the **2-way Navi-key** to scroll until **Call Meters** is highlighted.

4. Press the **left soft key**, labeled **Select**.

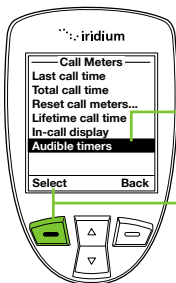

5. Use the **2-way Navi-key** to scroll until **Audible timers** is highlighted.

6. Press the **left soft key**, labeled **Select**.

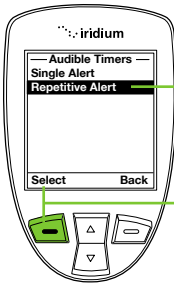

7. Use the **2-way Navi-key** to scroll to the **Repetitive Alert** option.
8. Press the **left soft key**, labeled **Select**.

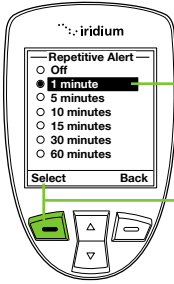

9. Use the **2-way Navi-key** to scroll to the desired repetitive alert.
10. Press the **left soft key**, labeled **Select**.

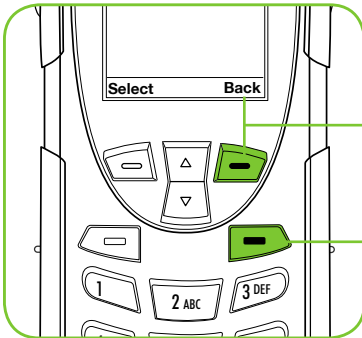

11. Press the **right soft key** labeled **Back** to return to the previous menu.
12. Press the **red key** to return to the **Main Screen**.

13: Using the Setup Menu

Locating the Setup Menu

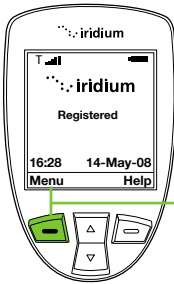

Starting from the **Main Screen**:

1. Press the **left soft key**, labeled **Menu**.

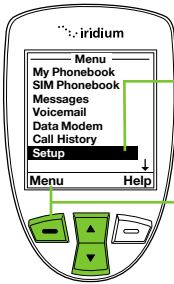

2. The **Main Menu** is displayed. Use the **2-way Navi-key** to scroll until **Setup** is highlighted.

3. Press the **left soft key**, labeled **Select**.

Note: All instructions for the **Setup** menu start from the **Main Menu** as shown.

About the Setup Menu

You can perform the following functions using the **Setup** menu:

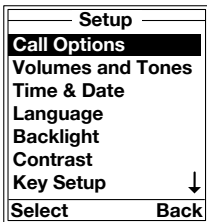

- Set call options.
- Set volumes and tones for your ringer speaker and alert.
- Set time zone, time and date format.
- Set language.
- Set your phone lighting preferences.
- Set the contrast on the display screen.

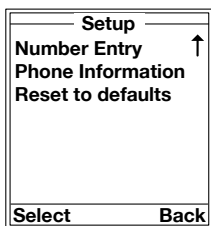

- Set preference for the convenience key and right soft key.
- Set your prefix preference for entering phone numbers.
- View phone information.
- Reset phone settings to default.

Note: The Setup menu consists of two screens. Scroll past the Key Setup option for more menu options.

Setting Call Options

The Call Options menu allows you to enable or disable various call capabilities.

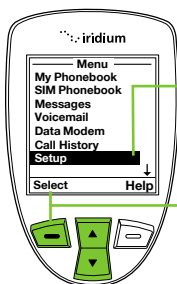

Starting from the **Main Menu**:

1. Use the **2-way Navi-key** to scroll until **Setup** is highlighted.
2. Press the **left soft key**, labeled **Select**.

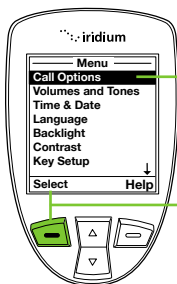

3. **Call Options** is already displayed.
4. Press the **left soft key**, labeled **Select**.

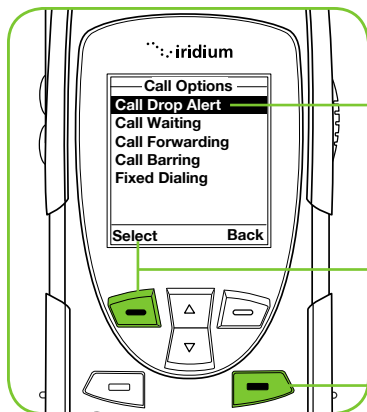

5. Highlight the call capability you would like to enable.
6. Press the **left soft key** labeled **Select** to return to the previous menu.
7. Press the **red key** to return to the **Main Screen**.

Setting Volumes and Tones

Adjust the Ringer Volume

The **Volumes and Tones** menu allows you to adjust your phone's ringer volume and tone, and set the phone to ring or vibrate to notify you of incoming calls.

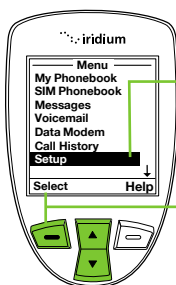

Starting from the **Main Menu**:

1. Use the **2-way Navi-key** to scroll until **Setup** is highlighted.
2. Press the **left soft key**, labeled **Select**.

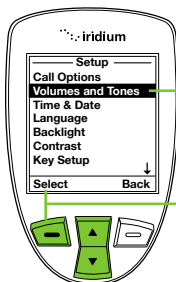

3. Use the **2-way Navi-key** to scroll until **Volumes and Tones** is highlighted.
4. Press the **left soft key**, labeled **Select**.

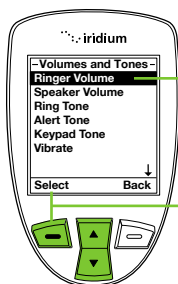

5. **Ringer Volume** is highlighted. If not, use the **2-way Navi-key** to scroll to it.
6. Press the **left soft key**, labeled **Select**.

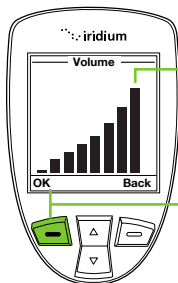

7. The volume bars increase or decrease as you press the **2-way Navi-key** up or down.
8. Press the **left soft key**, labeled **OK** when you have the desired setting.

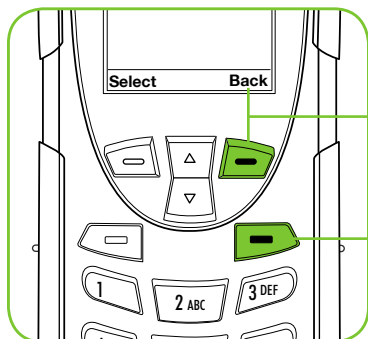

9. Press the **right soft key** labeled **Back** to return to the previous menu.
10. Press the **red key** to return to the **Main Screen**.

Adjust the Speaker Volume

This capability adjusts the volume of the speaker. The phone sounds the new volume level as you adjust it.

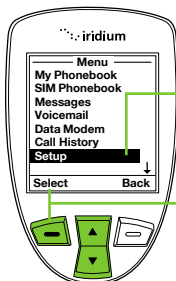

Starting from the **Main Menu**:

1. Use the **2-way Navi-key** to scroll until **Setup** is highlighted.

2. Press the **left soft key**, labeled **Select**.

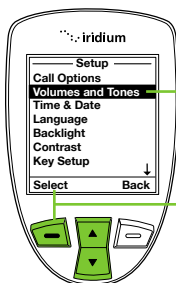

3. Use the **2-way Navi-key** to scroll until **Volumes and Tones** is highlighted.

4. Press the **left soft key**, labeled **Select**.

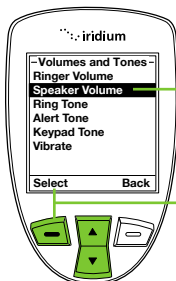

5. Use the **2-way Navi-key** to scroll to **Speaker Volume**.

6. Press the **left soft key**, labeled **Select**.

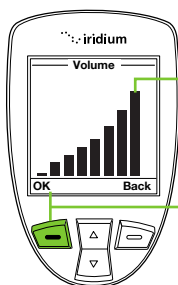

7. The volume bars increase or decrease as you press the **2-way Navi-key** up or down.
8. Press the **left soft key**, labeled **OK** when you have the desired setting.

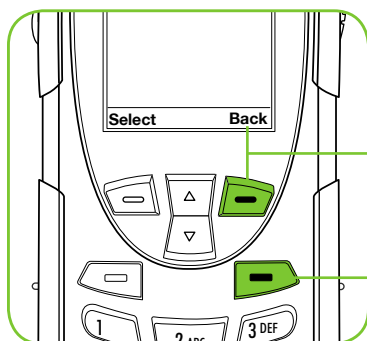

9. Press the **right soft key** labeled **Back** to return to the previous menu.
10. Press the **red key** to return to the **Main Screen**.

Adjust the Ring Tone

This capability adjusts the tone of the ringer. The phone sounds the new tone as you adjust it.

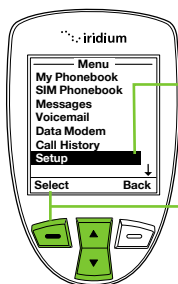

Starting from the **Main Menu**:

1. Use the **2-way Navi-key** to scroll until **Setup** is highlighted.
2. Press the **left soft key**, labeled **Select**.

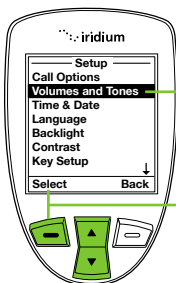

3. Use the **2-way Navi-key** to scroll until **Volumes and Tones** is highlighted.

4. Press the **left soft key**, labeled **Select**.

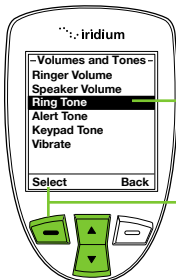

5. Use the **2-way Navi-key** to scroll to **Ring Tone**.

6. Press the **left soft key**, labeled **Select**.

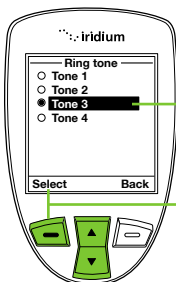

7. Use the **2-way Navi-key** to scroll to **Speaker Volume**.

8. Press the **left soft key**, labeled **Select**.

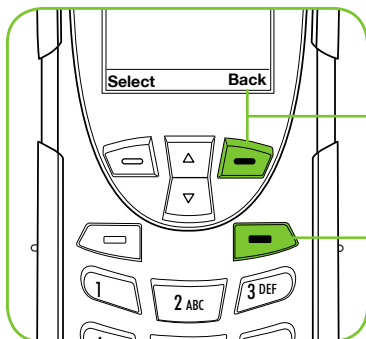

9. Press the **right soft key** labeled **Back** to return to the previous menu.

10. Press the **red key** to return to the **Main Screen**.

Setting the Call Alert Mode

This capability adjusts the alert tone. The phone sounds the new tone as you adjust it.

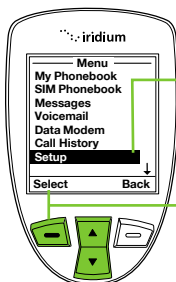

Starting from the **Main Menu**:

1. Use the **2-way Navi-key** to scroll until **Setup** is highlighted.

2. Press the **left soft key**, labeled **Select**.

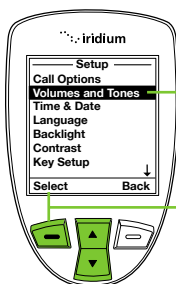

3. Use the **2-way Navi-key** to scroll until **Volumes and Tones** is highlighted.

4. Press the **left soft key**, labeled **Select**.

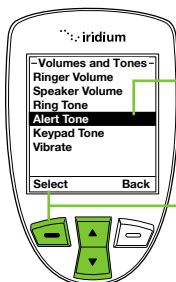

5. Use the **2-way Navi-key** to scroll until **Alert Tone** is highlighted.

6. Press the **left soft key**, labeled **Select**.

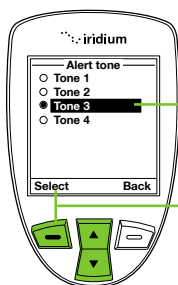

7. Use the **2-way Navi key** to scroll to the desired tone.

8. Press the **left soft key**, labeled **Select**.

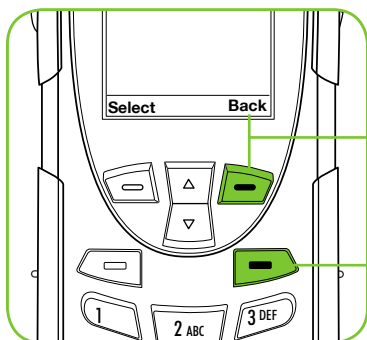

9. Press the **right soft key** labeled **Back** to return to the previous menu.

10. Press the **red key** to return to the **Main Screen**.

Setting the Keypad Tone

This capability selects the keypad tone. You can select to have a single tone, DTMF tones or no tones when the keypad is pressed.

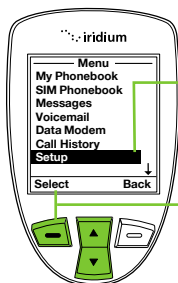

Starting from the **Main Menu**:

1. Use the **2-way Navi-key** to scroll until **Setup** is highlighted.

2. Press the **left soft key**, labeled **Select**.

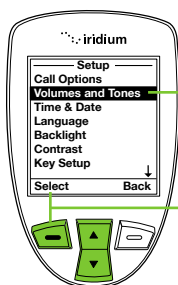

3. Use the **2-way Navi-key** to scroll until **Volumes and Tones** is highlighted.

4. Press the **left soft key**, labeled **Select**.

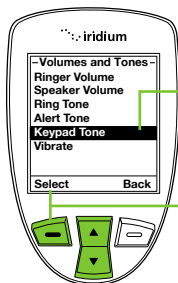

5. Use the **2-way Navi-key** to scroll until **Keypad Tone** is highlighted.

6. Press the **left soft key**, labeled **Select**.

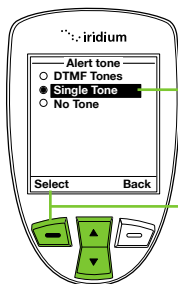

7. Use the **2-way Navi key** to scroll to the desired tone.

8. Press the **left soft key**, labeled **Select**.

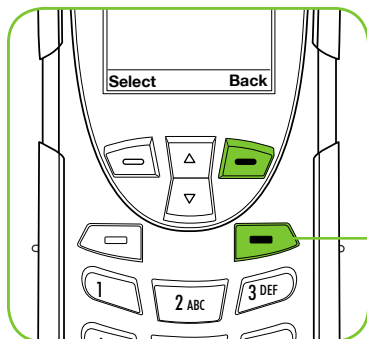

9. Press the **right soft key** labeled **Back** to return to the **Main Screen**.

Set the Phone to Ring and /or Vibrate

This capability is ideal for situations where a ringing phone is inappropriate or in a loud environment. The vibrate function notifies you of incoming calls with discreet vibrations.

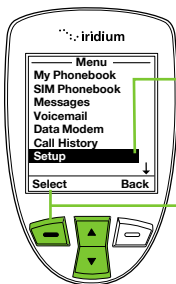

Starting from the **Main Menu**:

1. Use the **2-way Navi-key** to scroll until **Setup** is highlighted.
2. Press the **left soft key**, labeled **Select**.

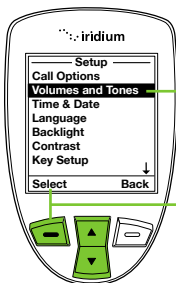

3. Use the **2-way Navi-key** to scroll until **Volumes and Tones** is highlighted.
4. Press the **left soft key**, labeled **Select**.

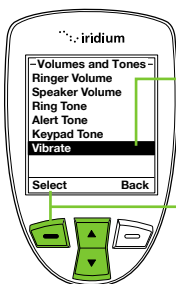

5. Use the **2-way Navi-key** to scroll until **Vibrate** is highlighted.
6. Press the **left soft key**, labeled **Select**.

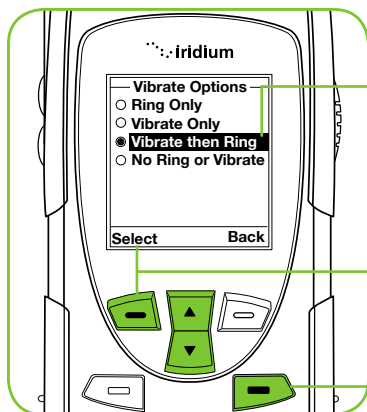

7. Use the **2-way Navi-key** to scroll to the desired **Vibrate Option**.

8. Press the **left soft key**, labeled **Select**.

9. Press the **right soft key** labeled **Back** to return to the **Main Screen**.

Time and Date Settings

Select the Time Zone

Your phone uses the satellite network to obtain the time and date information. However, you need to select the time zone in which you are located.

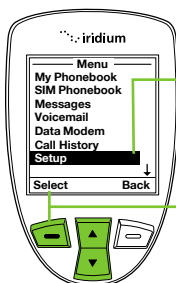

Starting from the **Main Menu**:

1. Use the **2-way Navi-key** to scroll until **Setup** is highlighted.

2. Press the **left soft key**, labeled **Select**.

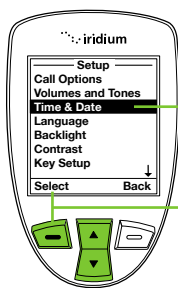

3. Use the **2-way Navi-key** to scroll until **Time & Date** is highlighted.

4. Press the **left soft key**, labeled **Select**.

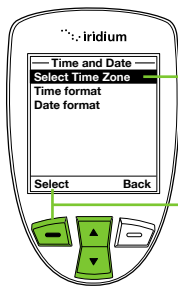

5. Use the **2-way Navi-key** to scroll until **Time Zone** is highlighted.

6. Press the **left soft key**, labeled **Select**.

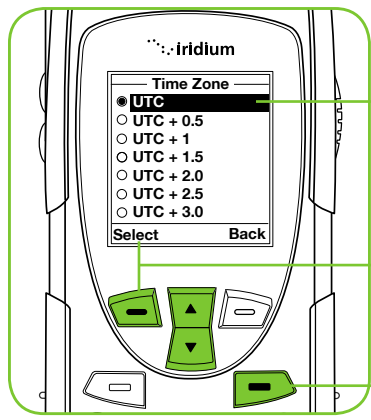

7. Use the **2-way Navi-key** until the required time zone is highlighted.

8. Press the **left soft key**, labeled **Select**.

9. Press the **right soft key** labeled **Back** to return to the **Main Screen**.

Select the Time Format

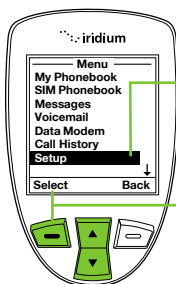

Starting from the **Main Menu**:

1. Use the **2-way Navi-key** to scroll until **Setup** is highlighted.

2. Press the **left soft key**, labeled **Select**.

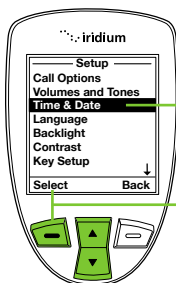

3. Use the **2-way Navi-key** to scroll until **Time and Date** is highlighted.

4. Press the **left soft key**, labeled **Select**.

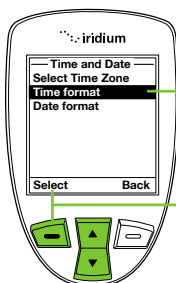

5. Use the **2-way Navi-key** to scroll until **Time Zone** is highlighted.

6. Press the **left soft key**, labeled **Select**.

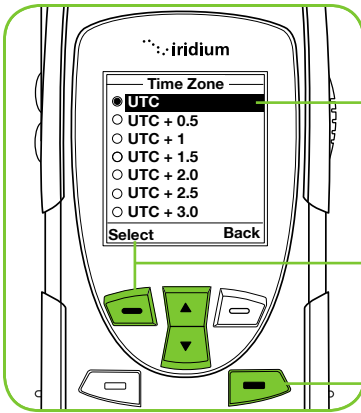

7. Use the **2-way Navi-key** until the required time zone is highlighted.
8. Press the **left soft key**, labeled **Select**.
9. Press the **right soft key** labeled **Back** to return to the **Main Screen**.

Select the Date Format

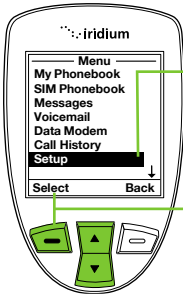

Starting from the **Main Menu**:

1. Use the **2-way Navi-key** to scroll until **Setup** is highlighted.
2. Press the **left soft key**, labeled **Select**.

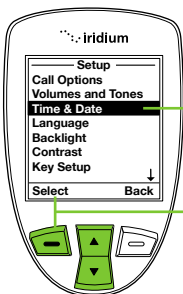

3. Use the **2-way Navi-key** to scroll until **Time and Date** is highlighted.
4. Press the **left soft key**, labeled **Select**.

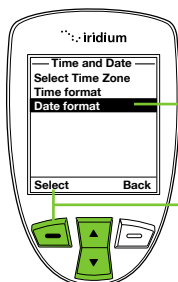

5. Use the **2-way Navi-key** to scroll until **Date format** is highlighted.
6. Press the **left soft key**, labeled **Select**.

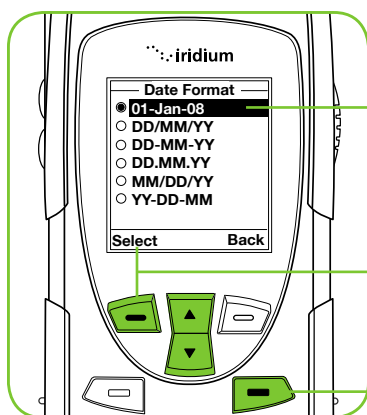

7. Use the **2-way Navi-key** until the required date format is highlighted.
8. Press the **left soft key**, labeled **Select**.
9. Press the **right soft key** labeled **Back** to return to the **Main Screen**.

Selecting the Display Language

Your phone contains 21 languages. Use this capability to select the language in which your phone displays menus and messages.

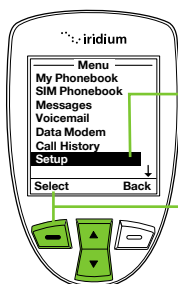

Starting from the **Main Menu**:

1. Use the **2-way Navi-key** to scroll until **Setup** is highlighted.
2. Press the **left soft key**, labeled **Select**.

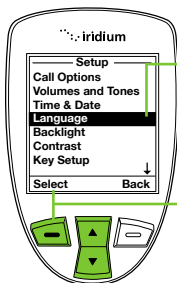

3. Use the **2-way Navi-key** to scroll until **Language** is highlighted.
4. Press the **left soft key**, labeled **Select**.

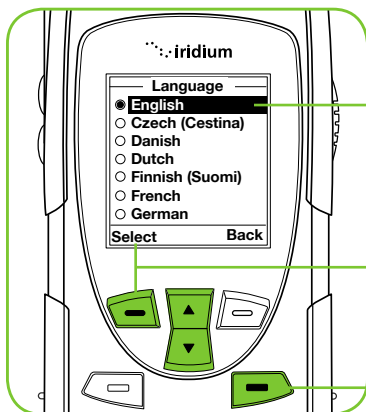

5. Use the **2-way Navi-key** to scroll until the required **Language** is highlighted.
6. Press the **left soft key**, labeled **Select**.
7. Press the **right soft key** labeled **Back** to return to the **Main Screen**.

Tip: If you accidentally select a language other than English and are unable to reset your phone, follow these steps:

1. Press the **left soft key**.
2. Scroll down six times.
3. Press the **left soft key** again.
4. Scroll down three times.
5. Press the **left soft key**, the **English** option is at the top.

Setting Backlights

Enable, disable or adjust the length of time the backlight stays on after a key press.

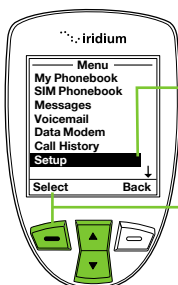

Starting from the **Main Menu**:

1. Use the **2-way Navi-key** to scroll until **Setup** is highlighted.

2. Press the **left soft key**, labeled **Select**.

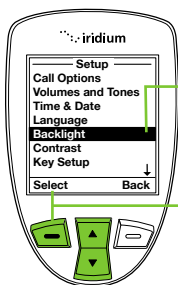

3. Use the **2-way Navi-key** to scroll until **Backlight** is highlighted.

4. Press the **left soft key**, labeled **Select**.

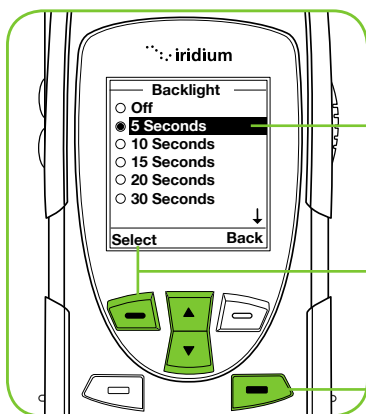

5. Use the **2-way Navi-key** to scroll until the required **Backlight** is highlighted.

6. Press the **left soft key**, labeled **Select**.

7. Press the **right soft key** labeled **Back** to return to the **Main Screen**.

Setting Contrast

This capability allows you to adjust the contrast on the display screen.

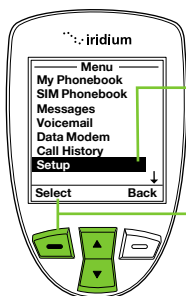

Starting from the **Main Menu**:

1. Use the **2-way Navi-key** to scroll until **Setup** is highlighted.

2. Press the **left soft key**, labeled **Select**.

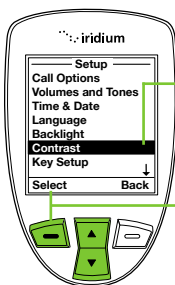

3. Use the **2-way Navi-key** to scroll until **Contrast** is highlighted.

4. Press the **left soft key**, labeled **Select**.

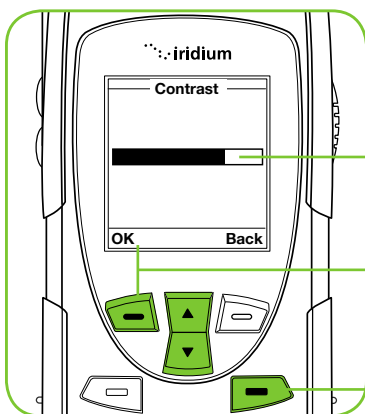

5. Use the **2-way Navi-key** to scroll until to increase or decrease the contrast.

6. Press the **left soft key**, labeled **Select**.

7. Press the **right soft key** labeled **Back** to return to the **Main Screen**.

Using the Key Setup Menu

This capability selects the function of the **convenience key** and the **right soft key** when the **Main Screen** is displayed. The default function is to display the Help screen which is useful for new users; however, the function can be changed to access the phonebook.

Setup the Convenience Key Function

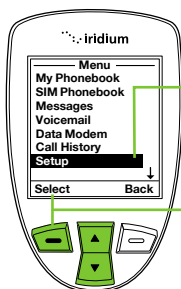

Starting from the **Main Menu**:

1. Use the **2-way Navi-key** to scroll until **Setup** is highlighted.

2. Press the **left soft key**, labeled **Select**.

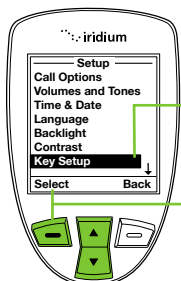

3. Use the **2-way Navi-key** to scroll until **Key Setup** is highlighted.

4. Press the **left soft key**, labeled **Select**.

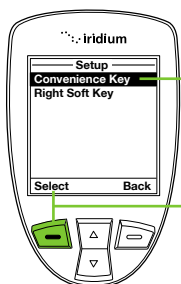

5. **Convenience Key** is highlighted.

6. Press the **left soft key**, labeled **Select**.

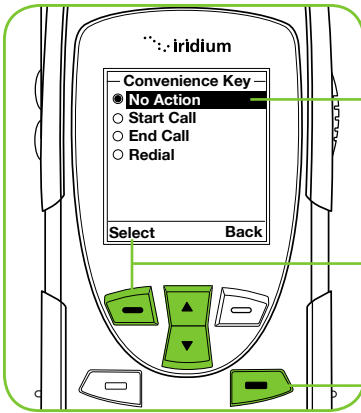

7. Use the **2-way Navi-key** to scroll until the desired action is highlighted.
8. Press the **left soft key**, labeled **Select**.
9. Press the **right soft key** labeled **Back** to return to the **Main Screen**.

Setup the Right Soft Key Function

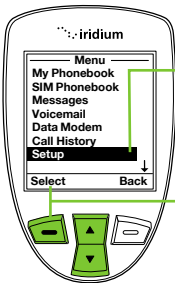

Starting from the **Main Menu**:

1. Use the **2-way Navi-key** to scroll until **Setup** is highlighted.
2. Press the **left soft key**, labeled **Select**.

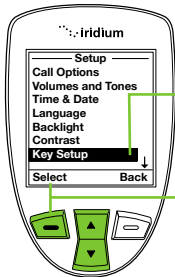

3. Use the **2-way Navi-key** to scroll until **Key Setup** is highlighted.
4. Press the **left soft key**, labeled **Select**.

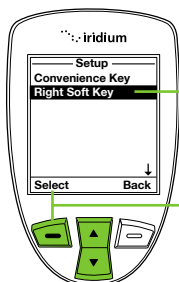

5. Use the **2-way Navi-key** until **Right Soft Key** is highlighted.

6. Press the **left soft key**, labeled **Select**.

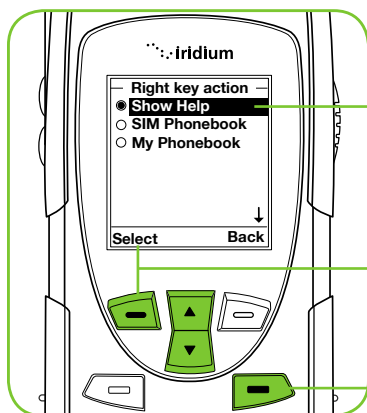

7. Use the **2-way Navi-key** to scroll until the desired action is highlighted.

8. Press the **left soft key**, labeled **Select**.

9. Press the **right soft key** labeled **Back** to return to the **Main Screen**.

Set Number Entry Prefix

This capability allows you to set your preferred international access code and can automatically attach (00) or (+) to any phone number you enter.

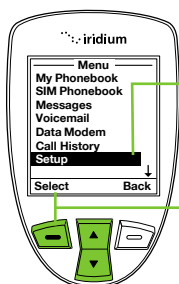

Starting from the **Main Menu**:

1. Use the **2-way Navi-key** to scroll until **Setup** is highlighted.

2. Press the **left soft key**, labeled **Select**.

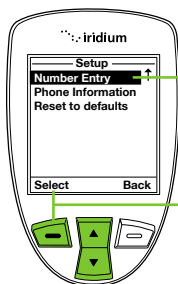

3. Use the **2-way Navi-key** to scroll past the **Key Setup** option until **Number Entry** is highlighted.
4. Press the **left soft key**, labeled **Select**.

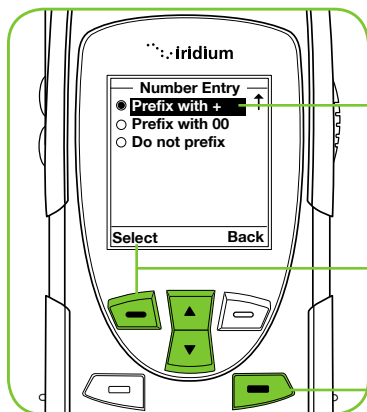

5. Use the **2-way Navi-key** to scroll until the desired action is highlighted.
6. Press the **left soft key**, labeled **Select**.
7. Press the **right soft key** labeled **Back** to return to the **Main Screen**.

View Phone Information

This capability allows you to view technical information about the Iridium 9555 Satellite Phone software, hardware versions and the IMEI number.

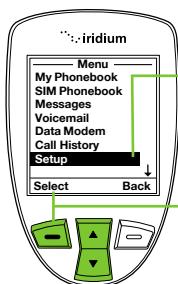

Starting from the **Main Menu**:

1. Use the **2-way Navi-key** to scroll until **Setup** is highlighted.
2. Press the **left soft key**, labeled **Select**.

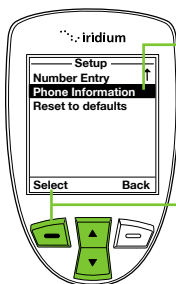

3. Use the **2-way Navi-key** to scroll past the **Key Setup** option until **Phone Information** is highlighted.

4. Press the **left soft key**, labeled **Select**.

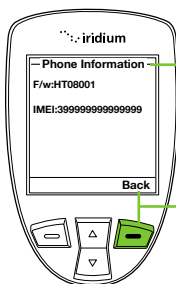

Information regarding your phone appears on the display.

5. Press the **right soft key**, labeled **Back** to return to the **Setup** menu.

Reset Phone Options to Factory Defaults

This capability resets all settings to their original default settings.

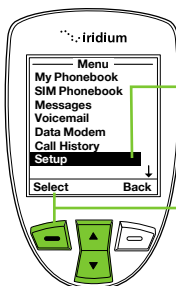

Starting from the **Main Menu**:

1. Use the **2-way Navi-key** to scroll until **Setup** is highlighted.

2. Press the **left soft key**, labeled **Select**.

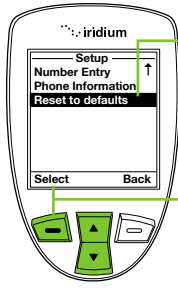

3. Use the **2-way Navi-key** to scroll past the **Key Setup** option until **Reset to defaults** is highlighted.

4. Press the **left soft key**, labeled **Select**.

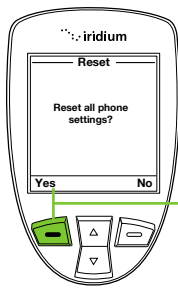

5. Press the **left soft key**, labeled **Yes**.

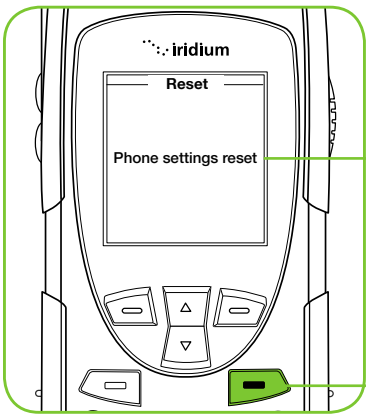

6. A message appears briefly indicating the phone settings have been reset.

7. Press the **red key** to return to the **Main Screen**.

14: Using the Security Menu

Important: Do not change the PIN/PUK/SIM settings unless you have your original settings available. Your phone and/or SIM card may be disabled if you don't know the correct code and enter it incorrectly three times. If a PIN becomes blocked, you must enter a Personal Unblocking Key (PUK) to restore the SIM to service which is obtained from your service provider.

Locating the Security Menu

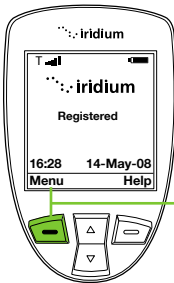

Starting from the **Main Screen**:

1. Press the **left soft key**, labeled **Menu**.

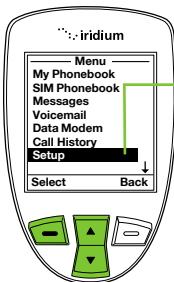

2. The **Main Menu** is displayed. Use the **2-way Navi-key** to scroll until **Security** is highlighted.

Note: All instructions for the **Security** menu start from the **Main Menu** as shown.

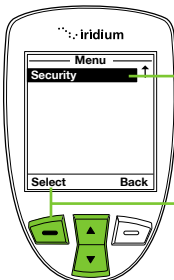

Note: Scroll one down from **Setup** to view the **Security** option.

3. Press the **left soft key**, labeled **Select**.

About the Security Menu

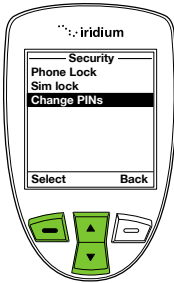

You can perform the following functions using the **Security** menu:

- Lock and unlock the phone.
- Enable and disable the SIM lock.
- Change PIN and block PIN codes.

Locking and Unlocking Your Phone

This capability helps prevent unwanted use of your phone.

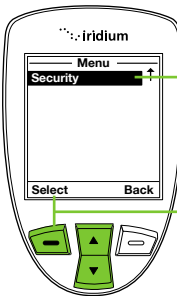

Starting from the **Main Menu**:

1. Use the **2-way Navi-key** to scroll until **Security** is highlighted.

Note: Scroll one down from **Setup** to view the **Security** option.

2. Press the **left soft key**, labeled **Select**.

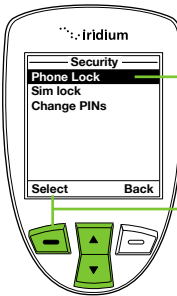

3. The **Phone lock** option is highlighted. If not, use the **2-way Navi-key** to scroll until it is.

4. Press the **left soft key**, labeled **Select**.

Using the GPS Options Menu

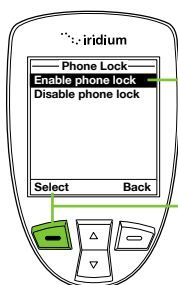

5. The **Enable phone lock** option is highlighted. If not, use the **2-way Navi-key** to scroll until it is.

6. Press the **left soft key**, labeled **Select**.

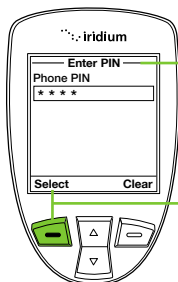

7. The **Enter PIN** screen appears. Using the keypad enter the PIN number.

8. Press the **left soft key**, labeled **Select**.

The Phone lock capability takes effect when you turn OFF your Iridium 9555 Satellite Phone. Each time you restart the phone, you are prompted to enter your Phone PIN. Once you do, the phone is fully operational.

Enable or Disable the SIM lock

When you activate the SIM lock capability, your phone requests your SIM PIN whenever your phone is powered on. To change this setting, you need to enter the SIM PIN code that your service provider gave you.

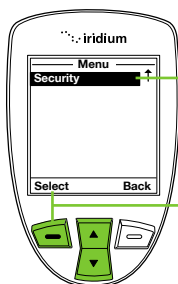

Starting from the **Main Menu**:

1. Use the **2-way Navi-key** to scroll until **Security** is highlighted.

Note: Scroll one down from **Setup** to view the **Security** option.

2. Press the **left soft key**, labeled **Select**.

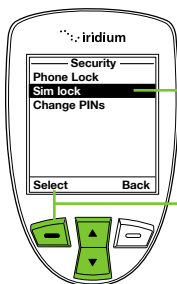

3. Use the **2-way Navi-key** to scroll until **SIM lock** is highlighted.

4. Press the **left soft key**, labeled **Select**.

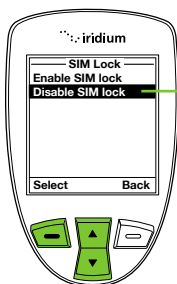

5. Use the **2-way Navi-key** until the action you prefer is highlighted.

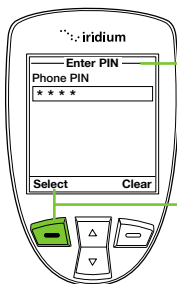

6. The **Enter PIN** screen appears. Using the keypad enter the PIN number.

7. Press the **left soft key**, labeled **Select**.

The message **SIM lock disabled** briefly appears, then returns to the SIM Lock menu.

Using the Change PIN Menu

Change the Phone PIN Code

This capability allows you to modify the default PIN associated with your phone.

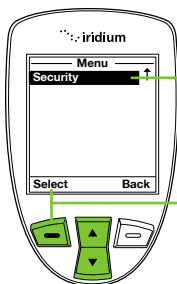

Starting from the Main Menu:

1. Use the **2-way Navi-key** to scroll until **Security** is highlighted.

Note: Scroll one down from **Setup** to view the **Security** option.

2. Press the **left soft key**, labeled **Select**.

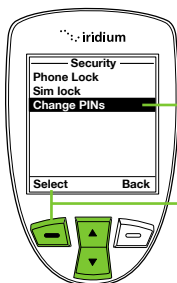

3. Use the **2-way Navi-key** to scroll until **Change PIN** is highlighted.

4. Press the left soft key, labeled **Select**.

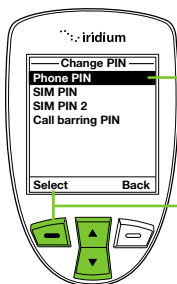

5. The **Change PIN** menu appears. **Phone PIN** is highlighted.

6. Press the **left soft key**, labeled **Select**.

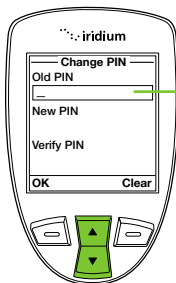

7. Enter your current PIN in the **Old PIN** field (the default PIN is 1234). Use the **2-way Navi-key** to move to the next field and enter your new PIN into the **New PIN** field. Move to the **Verify PIN** field and enter the new PIN again.

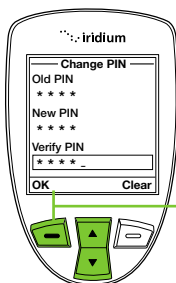

8. When all fields are complete, press the **left soft key**, labeled **OK**.

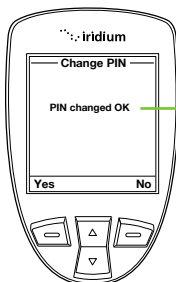

9. The screen displays **PIN changed OK** then returns to the **Change PIN** menu.

Change the SIM PIN Code

This capability allows you to modify the default PIN associated with your SIM card.

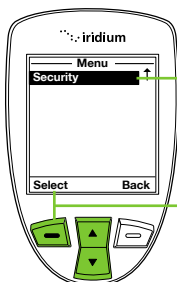

Starting from the Main Menu:

1. Use the **2-way Navi-key** to scroll until **Security** is highlighted.

Note: Scroll one down from **Setup** to view the **Security** option.

2. Press the **left soft key**, labeled **Select**.

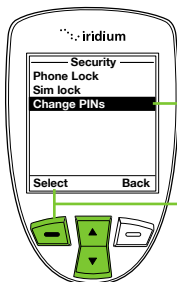

3. Use the **2-way Navi-key** to scroll until **Change PIN** is highlighted.

4. Press the **left soft key**, labeled **Select**.

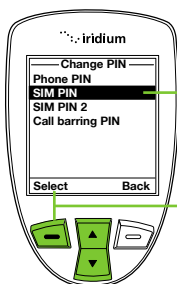

5. Use the **2-way Navi-key** to scroll until **SIM PIN** is highlighted.

6. Press the **left soft key**, labeled **Select**.

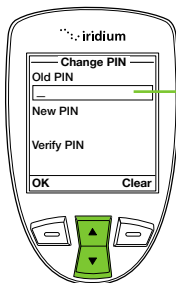

7. Enter your current PIN in the **Old PIN** field (the default PIN is 1111). Use the **2-way Navi-key** to move to the next field and enter your new PIN into the **New PIN** field. Move to the **Verify PIN** field and enter the new PIN again.

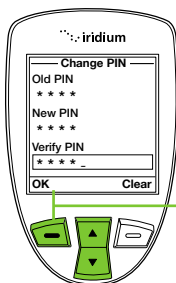

8. When all fields are complete, press the **left soft key**, labeled **OK**.

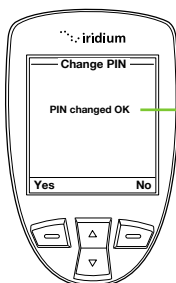

9. The screen displays **PIN changed OK** then returns to the **Change PIN** menu.

Change the SIM Card PIN2 Code

Your SIM card PIN2 code is used to access fixed dialing settings. This four to eight-digit code is issued to you when you subscribe to the capability.

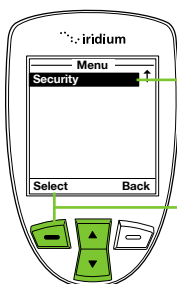

Starting from the Main Menu:

1. Use the **2-way Navi-key** to scroll until **Security** is highlighted.

Note: Scroll one down from **Setup** to view the **Security** option.

2. Press the **left soft key**, labeled **Select**.

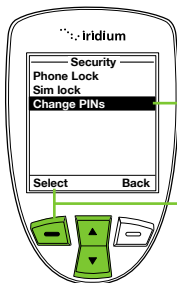

3. Use the **2-way Navi-key** to scroll until **Change PIN** is highlighted.

4. Press the **left soft key**, labeled **Select**.

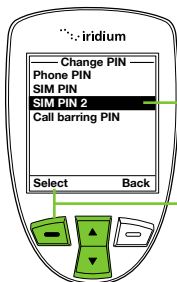

5. Use the **2-way Navi-key** to scroll until **SIM PIN 2** is highlighted.

6. Press the **left soft key**, labeled **Select**.

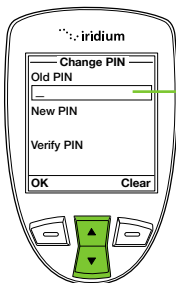

7. Enter your current PIN in the **Old PIN** field. Use the **2-way Navi-key** to move to the next field and enter your new PIN into the **New PIN** field. Move to the **Verify PIN** field and enter the new PIN again.

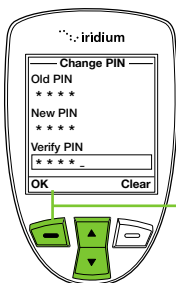

8. When all fields are complete, press the **left soft key**, labeled **OK**.

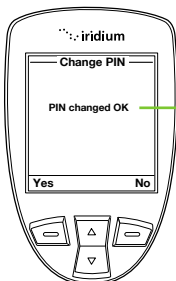

9. The screen displays **PIN changed OK** then returns to the **Change PIN** menu.

Call Barring PIN

Call Barring may be enabled for incoming and/or outgoing calls in the Setup, Call Options menu. When you enable Call Barring, you are prompted for a PIN. The Call Barring PIN may be changed as follows.

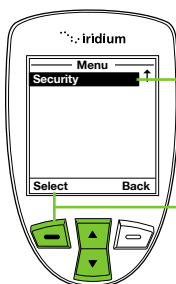

Starting from the Main Menu:

1. Use the **2-way Navi-key** to scroll until **Security** is highlighted.

Note: Scroll one down from **Setup** to view the **Security** option.

2. Press the **left soft key**, labeled **Select**.

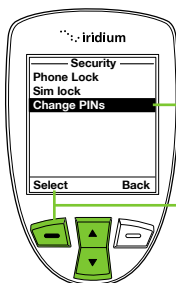

3. Use the **2-way Navi-key** to scroll until **Change PIN** is highlighted.

4. Press the **left soft key**, labeled **Select**.

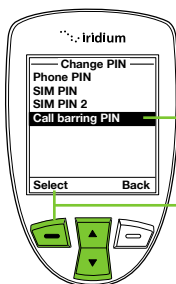

5. Use the **2-way Navi-key** to scroll until **SIM PIN 2** is highlighted.

6. Press the **left soft key**, labeled **Select**.

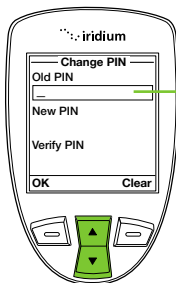

7. Enter your current PIN in the **Old PIN** field. Use the **2-way Navi-key** to move to the next field and enter your new PIN into the **New PIN** field. Move to the **Verify PIN** field and enter the new PIN again.

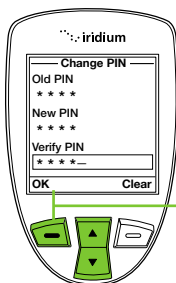

8. When all fields are complete, press the **left soft key**, labeled **OK**.

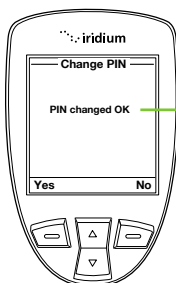

9. The screen displays **PIN changed OK** then returns to the **Change PIN** menu.

15: Troubleshooting

Problem	Solution
Phone won't power on.	<ul style="list-style-type: none">• Did you press and hold the power button for a minimum of three seconds to turn the phone's power on?• Check the battery. Is it charged, properly fitted, and are the contacts clean and dry?
You can't make calls.	<ul style="list-style-type: none">• Check the antenna. Is it fully extended and correctly angled? Do you have a clear unobstructed view of the sky?• Did you enter the number in international format? All calls made from the Iridium satellite system must be in international format. See "Placing a Call" on page 36.• Check the signal strength indicator. If the signal is weak, ensure that you have a clear line of sight to the sky and there are no buildings, trees, or other objects interfering.• Is Restricted displayed? Check the Call Barring setting.• Has a new SIM card been inserted? Check that no new restrictions have been imposed.• Check to see if your fixed dialing list is enabled. If so, you can only make calls to numbers or prefixes that are on the list.
You can't receive calls.	<ul style="list-style-type: none">• Check to see that your phone is powered on.• Check the antenna. Is it fully extended and correctly angled? Do you have a clear unobstructed view of the sky?• Check the signal strength indicator. If the signal is weak, ensure that you have a clear line of sight to the sky and there are no buildings, trees, or other objects around.• Check the Call Forwarding and Call Barring settings.• Check the Ringer setting. If it is off, there is no audible ringer.• Check to see if your fixed dialing list is enabled.

You can't make international calls.	<ul style="list-style-type: none"> • Have you included the relevant codes? Enter 00 or + followed by the appropriate country code and the phone number.
Your phone will not unlock.	<ul style="list-style-type: none"> • Have you inserted a new SIM card? Enter the new PIN code the default PIN is 1111). • Enter the default phone unlock code: 1234. • Have you forgotten the unlock code?
Your PIN is blocked.	<ul style="list-style-type: none"> • Enter the PIN unblocking code or contact your service provider. See "Using the Security Menu" on page 163 for more information.
Your PIN2 is blocked.	<ul style="list-style-type: none"> • Enter the PIN2 unblocking code or contact your service provider. See "Using the Security Menu" on page 165 for more information.
Your SIM card will not work.	<ul style="list-style-type: none"> • Is the SIM card inserted the correct way? • Is the card visibly damaged or scratched? Return the card to your service provider. • Check the SIM and card contacts. If they are dirty, clean them with an antistatic cloth.
You can't cancel Call Forwarding or Call Barring .	Wait until you are in an area with good network coverage and try again.
The message indicator is flashing.	There is not enough memory available to store another message. Use the messages menu to delete one or more messages.
The battery won't charge.	<ul style="list-style-type: none"> • Check the charger. Is it properly connected? Are its contacts clean and dry? • Check the battery contacts. Are they clean and dry? • Check the battery temperature. If it is warm, let it cool before charging. • Is it an old battery? Battery performance declines after several years of use. Replace the battery. • Make sure you have an Iridium approved battery installed. If you see? on the display near the charging icon, you cannot charge this battery.

<p>The battery drains faster than normal.</p>	<ul style="list-style-type: none"> • Are you in an area of variable coverage? This uses extra battery power. • Is your antenna fully extended and correctly angled? Do you have a clear unobstructed view of the sky? This helps use less battery power. • Is it a new battery? A new battery needs two to three charge/discharge cycles to attain normal performance. • Is it an old battery? Battery performance declines after several years of use. Replace the battery. • Is it a battery that hasn't been completely discharged? Allow the battery to fully discharge (until the phone turns itself off) and then charge the battery overnight. • Are you using your phone in extreme temperatures? At extreme hot or cold temperatures, battery performance is significantly reduced.
<p>You find your phone becoming warm during use.</p>	<p>You may notice this during long calls or during charging. The heat is produced by the electronic components within your phone and is quite normal.</p>
<p>Phone is not responding to user controls including the power keys.</p>	<p>Remove the battery from the phone and then reattach it to cycle power and reset.</p>
<p>Your SIM card is inserted in the phone, but the display says:</p> <p>Check Card or Insert Card or Blocked</p>	<p>Check Card or Insert Card</p> <p>Check that the SIM card has been inserted correctly. The contacts of the SIM card may be dirty. Turn the phone off, remove the SIM card and rub the contacts with a clean cloth. Replace the card in the phone.</p> <p>Blocked</p> <p>Enter the PIN unblocking key or contact your service provider. See "Call Barring PIN" on page 167 for additional information.</p>

<p>Your phone is displaying an unknown foreign language and you would like to restore it to its original setting.</p>	<ul style="list-style-type: none">• Power on the phone.• Press left soft key for menu.• Press down six times for Setup, then left soft key for Select.• Press down three times for Languages, then left soft key for Select.• Press left soft key for Select.
<p>Phone states "Searching for Network."</p>	<ul style="list-style-type: none">• Ensure you are in an area with an open view of the sky.• Extend the antenna and point upright towards the sky directly above in order to receive a signal.• If your phone was powered on inside of a building or area with an obstructed view of the sky just prior to attempting a call outside, the phone may be temporarily in a power saving mode to conserve battery life. You may either wait for it to automatically exit the power saving mode within a minute or two on its scheduled interval or just simply turn off your phone and turn it on again to accelerate the registration process.

17: Certification and Compliance Information

Export Compliance

The sale and use of the Iridium 9555 Satellite Phone is controlled by the export laws and regulations of the United States of America. The U.S. Government may restrict the export or re-export of this device to certain individuals and/or countries. For further information, contact the U.S. Department of Commerce, Bureau of Industry and Security or visit www.bis.doc.gov.

Standards Compliance Information

The Iridium 9555 Satellite Phone is designed to comply with the standards for Radiofrequency Radiation Compliance, Electromagnetic Compatibility, and AC Safety in the United States, European Union, Canada and Mexico.

U.S. Federal Communications Commission

The Iridium 9555 Satellite Phone, holds a Certification from the Federal Communications Commission under 47 CFR Part 25 as FCC Identifier: Q639555A. It also complies with Part 15 of the FCC Regulations. Operation is subject to the conditions that this device does not cause harmful interference and the device must accept any interference received including interference that may cause undesired operation. Any unauthorized antennas, modifications or attachments to this device could damage the Iridium 9555 Satellite Phone and may violate FCC regulations and void your authority to operate this device.

EU Regulatory Conformity

The Iridium 9555 Satellite Phone complies with the essential requirements and other relevant provisions of the EU Radio Equipment Directive 2014/53/EU. The full text of the declaration of conformity is available at www.iridium.com.

Canada Regulatory Conformity

The Iridium 9555 Satellite Phone complies with Innovation, Science and Economic Development Canada RSS-170. Certification Number IC 4629A-9555. CAN ICES-3 (B) / NMB-3 (B) This Class B digital apparatus complies with Canadian ICES-003.

Transmit Power and Frequencies

Transmit Power (average power in the transmit burst): EIRP = 40.7dBm +/- 0.7dB *1; Conducted power at antenna port = 36.5dBm +/- 0.7dB. Transmit frequency band: 1616MHz - 1626MHz Receive frequency band: 1616MHz - 1626.5MHz.

18: Limited Warranty

Including Exclusions, Disclaimers, Limitations of Liability and Conditions of Use; Warranty Claim Process and Privacy and Data Security

This Limited Warranty including Exclusions, Disclaimers, Limitations of Liability and Conditions of Use, and Dispute Resolution by Binding Arbitration (“Limited Warranty”) applies only to the Iridium 9555 Satellite Phone (including hardware, software and firmware) and the Accessories listed herein (collectively, “Product”) sold by Iridium or its authorized manufacturer, resellers and distributors (collectively, “Service Providers”). This Limited Warranty extends only to the first retail purchaser of the Product (“You”) and is not assignable or transferable.

Subject to the Exclusions contained below, Iridium warrants to You that the Product will be free from defects in materials and workmanship under normal usage for a period of one year from the date of original retail purchase (the “Warranty Period”), and if Iridium receives, during the Warranty Period and in accordance with the instructions set out in this Limited Warranty, notice of a defect in the Product covered by this Limited Warranty, Iridium will repair or replace the Product or refund the purchase price of the Product, at Iridium’s sole option. Iridium shall have no obligation to repair, replace, or refund unless the defective Product is returned in accordance with the instructions set out in this Limited Warranty and within the Warranty Period. You are required to provide proof of purchase as a condition of receiving warranty service as more fully described in “Warranty Claim Process” below.

Any replacement products or parts may contain new and used materials equivalent to new in performance and reliability. Any replacement product or part will also have functionality at least equal to that of the product or part being replaced. Replacement products and parts are warranted to be free from defects in material or workmanship under normal usage for the remainder of the applicable Warranty Period of the original Product for which a replacement product or part is provided under this Limited Warranty. A returned Product for which a replacement has been provided shall become Iridium’s property.

IRIDIUM DOES AND MAY CONTINUE, AT ITS SOLE DISCRETION, TO SUBCONTRACT TO AND ENGAGE A THIRD PARTY TO PROVIDE THE WARRANTY SERVICES PROVIDED FOR IN THIS LIMITED WARRANTY.

If you acquired this Product in Australia or in New Zealand, this Product comes with guarantees that cannot be excluded under the Australian Consumer Law or similar legislation in New Zealand. Notwithstanding

other express terms and other limitations of this Limited Warranty (which other express terms and other limitations are negated by this paragraph, but only to the extent inconsistent with this paragraph, and will not be applied to limit consumer rights under such guarantees), where such guarantees operate, consumers are entitled to a replacement or a refund for a major failure of this Product and for compensation for any other reasonably foreseeable loss or damage. Where such guarantees operate, consumers are also entitled to have this Product repaired or replaced if this Product fails to be of acceptable quality and the failure does not amount to a major failure. Please follow the instructions as to use and report problems promptly: problems caused by use that is abnormal or contrary to instructions will generally not be covered. You should contact your Product provider in relation to problems with the Product and Iridium will assist your Product provider to resolve them, including replacement where required.

Exclusions

This Limited Warranty does not apply in the following circumstances:

Normal wear and tear. Periodic maintenance, repair or replacement of parts due to normal wear and tear are excluded from coverage.

Batteries. Only batteries whose fully charged capacity falls below 80% of rated capacity and batteries that leak are covered by this Limited Warranty. Batteries that are charged by other than an Iridium-approved battery charger; having seals that are broken or show evidence of tampering; are used in equipment other than the Product; or are charged and stored at temperatures greater than 60 degrees centigrade, are excluded from coverage.

Abuse and Misuse. Defects or damage that result from improper operation or storage, misuse or abuse, accident or neglect; exposure to open, uncovered connectors including contact with liquid, water, rain, extreme humidity or heavy perspiration, sand, dirt or the like, extreme heat or spills of food, use of the Product for abnormal purposes, stretching coil cords or breaking coil cord modular tabs, breakage or damage to antennas or scratches or other damage to plastic surfaces or other externally exposed parts caused by your use, or other acts which are not the fault of Iridium, are excluded from coverage.

Use of Non-Iridium Products and Accessories. Defects or damage that result from the use of non-Iridium branded products (other than the antenna supplied with your Product), accessories or software or other ancillary or peripheral equipment are excluded from coverage.

Unauthorized Service or Modifications. Defects or damage resulting from any service, testing, adjustment, integration, installation, operation, maintenance, service, alteration, modification or integration with any non-Iridium product in any manner other than in accordance with Product user documentation and instructions and/or by someone other than Iridium or a Service Provider are excluded from coverage.

Altered Products. Products that have been tampered with, altered, disassembled, have non-Iridium housings or parts, or have had the serial numbers or date tags removed, altered or obliterated are excluded from coverage.

Communication Services. Defects, damages or failure of the Product due to any non-Iridium communication service or signal or use of a non-Iridium branded communication service or signal are excluded from coverage.

Software Embodied in Physical Media. No warranty is made that any software will meet your requirements or will work in combination with any hardware or software applications provided by third parties, that the operation of the software will be uninterrupted or error free, or that all defects in the software will be corrected.

Privacy and Data Security. No warranty is made that any communications engaged in while using the Product will be secure or private.

Disclaimers

THIS LIMITED WARRANTY IS EXPRESSLY IN LIEU OF ANY OTHER WARRANTIES, EITHER EXPRESS OR IMPLIED, REPRESENTATIONS, GUARANTEES, OR CONDITIONS, INCLUDING WITHOUT LIMITATION, ANY IMPLIED REPRESENTATIONS, GUARANTEES, CONDITIONS OR WARRANTIES OF MERCHANTABILITY AND FITNESS FOR A PARTICULAR PURPOSE, NON-INFRINGEMENT, SATISFACTORY QUALITY, NON-INTERFERENCE, ACCURACY OF INFORMATIONAL CONTENT, OR ARISING FROM A COURSE OF DEALING, LAW, USAGE, OR TRADE PRACTICE, OR RELATED TO THE PERFORMANCE OR NONPERFORMANCE OF ANY PRODUCTS, ACCESSORIES, FACILITIES OR SERVICES. ANY OTHER STANDARDS OF PERFORMANCE, GUARANTEES, CONDITIONS AND WARRANTIES ARE HEREBY EXPRESSLY DISCLAIMED TO THE FULLEST EXTENT PERMITTED BY LAW. THIS DISCLAIMER SHALL APPLY EVEN IF THIS EXPRESS LIMITED WARRANTY FAILS OF ITS ESSENTIAL PURPOSE. FURTHER, THIS LIMITED WARRANTY COVERS THE PRODUCT ONLY, AND NO WARRANTY IS MADE AS TO USER INFORMATION AND/OR TO COVERAGE, AVAILABILITY OR GRADE OF SERVICE PROVIDED BY IRIDIUM SEPARATELY FOR IRIDIUM SATELLITE SERVICES.

ANY IMPLIED WARRANTIES THAT MAY BE IMPOSED BY LAW, INCLUDING, WITHOUT LIMITATION, THE IMPLIED WARRANTIES OF MERCHANTABILITY AND FITNESS FOR A PARTICULAR PURPOSE, SHALL BE LIMITED TO THE DURATION OF THIS LIMITED WARRANTY.

Limitations of Liability and Conditions of Use.

This Limited Warranty is your sole and exclusive remedy. These terms and conditions supersede any prior agreements or representations, including those made in Iridium sales literature or advice given to you by Iridium or an Iridium Service Provider in connection with your purchase.

IN NO EVENT SHALL IRIDIUM BE LIABLE, WHETHER IN CONTRACT OR TORT OR ANY OTHER LEGAL THEORY, INCLUDING WITHOUT LIMITATION STRICT LIABILITY, GROSS NEGLIGENCE OR NEGLIGENCE, FOR ANY DAMAGES IN EXCESS OF THE PURCHASE PRICE OF THE PRODUCT AND/OR THE COST OF IRIDIUM SATELLITE SERVICES PROVIDED. NOR SHALL IRIDIUM BE LIABLE FOR ANY DIRECT, INDIRECT, INCIDENTAL, SPECIAL, CONSEQUENTIAL, OR PUNITIVE DAMAGES OF ANY KIND, OR LOSS OF REVENUE OR PROFITS, LOSS OF BUSINESS, LOSS OF PRIVACY, LOSS OF USE, LOSS OF TIME OR INCONVENIENCE, LOSS OF INFORMATION OR DATA, SOFTWARE OR APPLICATIONS OR OTHER FINANCIAL LOSS CAUSED BY THE PRODUCT AND/OR THE IRIDIUM SATELLITE SERVICES, OR ARISING OUT OF OR IN CONNECTION WITH THE ABILITY OR INABILITY TO USE, OR THE USE OF THE PRODUCT AND/OR THE IRIDIUM SATELLITE SERVICES, TO THE FULLEST EXTENT THESE DAMAGES MAY BE DISCLAIMED BY LAW AND REGARDLESS OF WHETHER IRIDIUM WAS ADVISED OF THE POSSIBILITIES OF SUCH DAMAGES. IRIDIUM IS NOT LIABLE FOR ANY CLAIM MADE BY A THIRD PARTY OR MADE BY YOU FOR A THIRD PARTY.

USERS OF THE IRIDIUM SATELLITE PHONE SERVICES AND RELATED EQUIPMENT, INCLUDING WITHOUT LIMITATION THOSE USING THE SERVICE AND THE PRODUCT IN ANY MANNER IN CONJUNCTION WITH EMERGENCY 911 (U.S.), EMERGENCY TRIPLE ZERO (000)/ 112 (AUSTRALIA), OR ANY OTHER DISTRESS CALLING OR EMERGENCY SERVICES, BOTH PUBLIC OR PRIVATELY OPERATED, ACKNOWLEDGE AND AGREE AS A CONDITION OF THE PROVISION OF PHONE SERVICE AND PRODUCT BY IRIDIUM THAT THEY WILL MAKE NO CLAIM, WHETHER IN CONTRACT, INDEMNITY, TORT OR ANY OTHER LEGAL THEORY AGAINST IRIDIUM FOR BODILY INJURY, LOSS OF LIFE, DAMAGE TO PROPERTY OR FOR ANY OTHER LOSS WHATSOEVER, OR FOR SPECIAL, INCIDENTAL, INDIRECT, CONSEQUENTIAL OR PUNITIVE DAMAGES, BY REASON OF ANY UNAVAILABILITY, DELAY, FAULTINESS OR FAILURES OF THE IRIDIUM FACILITIES OR SERVICE, PRODUCT, OR EQUIPMENT OR FOR INACCURACIES OR FAILURES WITH REGARD TO

ANY USER INFORMATION PROVIDED. THIS IS A WAIVER, RELEASE AND DISCLAIMER OF WARRANTY AND LIMITATION OF LIABILITY TO THE FULLEST EXTENT PERMITTED BY APPLICABLE LAW AND APPLIES REGARDLESS OF THE CAUSE OF ANY LIABILITY, INCLUDING WITHOUT LIMITATIONS, TO WRONGFUL CONDUCT, OMISSION OR FAULT OF EMPLOYEES OR AGENTS OF IRIDIUM.

You are permitted to use the Product only as described and specified in this Limited Warranty (including Exclusions, Disclaimer of Warranties, Limitations of Liability and Conditions of Use). By using the Product, you are indicating that you agree to comply with the terms of this Limited Warranty. If you fail to comply with this Limited Warranty, Iridium may void certain protections offered under the Limited Warranty and Iridium reserves the right to terminate your right to use the Product on the Iridium system. If you do not accept the terms of this Limited Warranty, do not use the Product on the Iridium system.

You are permitted to use the Product only in connection with service on the Iridium system using airtime purchased from your Service Provider. You are required to comply with this Limited Warranty, as well as all terms and conditions that are provided separately by your Service Provider, as such terms and conditions may change from time to time. Iridium or your Service Provider may also establish additional terms and conditions from time to time. In the event any Iridium term or condition conflicts with any Service Provider term or condition, the Iridium term or condition shall govern. Service provider will be provided with notice of any new terms and conditions or any changes in these terms and conditions. All terms and conditions will be effective as of your receipt of the notices of new or modified terms and conditions, and your continued use of the Product on the Iridium system after such receipt shall constitute your acceptance of such new or modified terms.

You may not use the Product in connection with any third-party devices, including but not limited to computers, cameras, batteries, GPS devices, recorders or other devices which alter the information sent or received by the Product, except to the extent that Iridium has certified those devices and confirmed that their use will have no adverse effect on the Iridium system. All devices approved by Iridium will be advertised and labeled as being approved by Iridium and you may use only "Iridium Certified Devices" with this Product and with the Iridium system.

You may not modify the Product or any component of the Product. You may not reverse-engineer, or attempt to reverse-engineer, the Product, any component of any Product or the manner in which the Product connects to, sends information to, receives information from, or otherwise interacts with the Iridium system.

Defense and Indemnity for Unauthorized Use. You are required to comply with all applicable laws and regulations in your use of the Product. To the extent that you: (i) violate this Limited Warranty, the terms and conditions applicable to the Iridium system or other agreements between you and Iridium, or between you and your Service Provider; (ii) utilize a product other than an Iridium-Approved Device on the Iridium system; (iii) modify the Product or any Product component, reverse-engineer the Product or any Product component or attempt to do so; or (iv) violate any applicable laws or regulations (collectively “Unauthorized Use”), you agree to defend, indemnify and hold Iridium and your Service Provider harmless with respect to any claims or actions by governmental entities or other third parties related to your Unauthorized Use and to pay all costs, damages, fines and other amounts incurred by us, or on our behalf, in the defense of any such claims or actions. Further, we specifically disallow any liability and will not credit back airtime charges related to any Unauthorized Use.

In addition to Iridium’s express reservation of other remedies available to it, Iridium reserves the right to discontinue providing Iridium Satellite Services and/or to disable your Product’s access to the Iridium system. If Iridium reasonably believes that you are engaged in any Unauthorized Use, we may seek equitable relief to prevent such Unauthorized Use without having to wait to see if damage to the Iridium system occurs.

This Product is covered by a U.S.A. warranty.

This Limited Warranty is applicable in all countries and is enforceable in any country or region where Iridium or its Service Provider offer warranty service for the Product. Outside of the U.S.A., any different warranty terms, liabilities and/or legal requirements of the country in which the Product is sold are specifically disclaimed by Iridium to the extent permitted by law. Warranty service availability and response times may vary from country to country and may be subject to registration requirements in the country of purchase. Your Iridium Service Provider can provide details.

This Limited Warranty gives you specific legal rights, and you may also have other rights that may vary from state to state and country to country. Some states/countries do not allow limitations on how long an implied warranty lasts, so the above limitation may not apply to you. Some states do not allow the exclusion or limitation of incidental or consequential damages, so the above limitation or exclusion may not apply to you. You are advised to consult applicable state/country laws for a full determination of your rights.

Warranty Claim Process

Should your Product require service within the Warranty Period or for warranty questions, repairs or for the return of the Product, **please contact your Service Provider or any other Service Provider in your country. Do not contact Iridium.** For warranty claims, you will be required to provide the following proof of purchase documentation: your dated bill of sale or delivery receipt (including your name, address and telephone number; the name and address of the Service Provider who sold you the Product; the model number and International Mobile Identification Number (IMEI); and the sale price of the Product), together with a written description of the problem. You are responsible for shipping the Product to the authorized warranty service center designated by your Service Provider with freight and insurance prepaid. Product that is repaired or replaced under this Limited Warranty shall be shipped to your Service Provider who will work with you to arrange transfer of the product. In certain states/countries, including without limitation Australia and New Zealand, the law requires that manufacturers or sellers incur costs relating to the warranty return and replacement of any products. In those jurisdictions, Iridium and/or the Service Provider will pay the costs of return and/or replacement, as required.

Refer to www.iridium.com for a list of Service Providers or contact your Service Provider for warranty information.

Privacy and Data Security.

Privacy and data security are important to everyone. Some features of your Product may affect your privacy or data security. Therefore, it is important to monitor access to your Product and not to leave it where others might have unmonitored access. Lock your Product when not in use. Erase all personal information or data before disposing of the Product or recycling it. The Product uses network-based positioning technology, which may be used to obtain a user's approximate location and thereby affect a user's privacy.

Disclosure to Governmental and Quasi-Governmental Agencies

By your use of the Product and Iridium Satellite Services you consent to Iridium's disclosure of user information, including, but not limited to name, address, telephone number and location information, including, where available, the geographic coordinates of equipment, to governmental and quasi-governmental agencies where Iridium deems it necessary in its sole discretion to respond to an exigent circumstance.

These governmental and quasi-governmental agencies shall be deemed "users" for all purposes of this Limited Warranty.

SOFTWARE LICENSE

The following terms govern your access and use of the Iridium or Iridium-supplied software (“Software”) contained on the Product you purchased.

License. Conditioned upon compliance with the terms and conditions of this Limited Warranty, Iridium grants to you a nonexclusive and nontransferable license to use for your internal purposes the Software and the Documentation. “Documentation” means written information (whether contained in user or technical manuals, training materials, specifications or otherwise) pertaining to the Software and made available by Iridium with the Software in any manner. You shall use the Software solely as embedded in (or, if downloaded, as provided via download), for execution on, and for communication via the Iridium system.

No other licenses are granted by implication, estoppel or otherwise.

General Limitations. This is a license, not a transfer of title, to the Software and Documentation, and Iridium retains ownership of all copies of the Software and Documentation. You acknowledge that the Software and Documentation contain trade secrets of Iridium or its suppliers or licensors, including but not limited to the specific internal design and structure of individual programs and associated interface information. Except as otherwise expressly provided, you shall have no right, and you specifically agree not to:

- (i) transfer, assign or sublicense your license rights to any other person or entity (other than in compliance with any Iridium relicensing/transfer policy then in force), or use the Software on unauthorized or secondhand Iridium equipment, and you acknowledge that any attempted transfer, assignment, sublicense or use shall be void;
- (ii) make error corrections to or otherwise modify or adapt the Software or create derivative works based upon the Software, or permit third parties to do the same;
- (iii) reverse engineer or decompile, decrypt, disassemble or otherwise reduce the Software to human-readable form, except to the extent otherwise expressly permitted under applicable law notwithstanding this restriction;
- (iv) use or permit the Software to be on a service bureau or time sharing basis or otherwise, without the express written authorization of Iridium; or

- (v) disclose, provide, or otherwise make available trade secrets contained within the Software and Documentation in any form to any third party without the prior written consent of Iridium. You shall implement reasonable security measures to protect such trade secrets.

To the extent required by law, and at your written request, Iridium shall provide you with the interface information needed to achieve interoperability between the Software and another independently created program, on payment of Iridium's applicable fee, if any. You shall observe strict obligations of confidentiality with respect to such information and shall use such information in compliance with any applicable terms and conditions upon which Iridium makes such information available.

Software, Upgrades and Additional Copies. "Software" shall include computer programs, including firmware, as provided to you by Iridium or a Service Provider, and any upgrades, updates, bug fixes or modified versions thereto (collectively, "Upgrades") or backup copies of any of the foregoing. NOTWITHSTANDING ANY OTHER PROVISION OF THE AGREEMENT: (1) UNLESS AUTHORIZED BY IRIDIUM, YOU HAVE NO LICENSE OR RIGHT TO MAKE OR USE ANY ADDITIONAL COPIES OR UPGRADES. IRIDIUM MAY MAKE SOFTWARE AVAILABLE BASED ON ADDITIONAL TERMS; (2) USE OF UPGRADES IS LIMITED TO IRIDIUM EQUIPMENT FOR WHICH YOU ARE THE ORIGINAL END USER PURCHASER OR OTHERWISE HOLD A VALID LICENSE TO USE THE SOFTWARE WHICH IS BEING UPGRADED; AND (3) THE MAKING AND USE OF ADDITIONAL COPIES IS LIMITED TO NECESSARY BACKUP PURPOSES ONLY.

Proprietary Notices. You agree to maintain and reproduce all copyright and other proprietary notices on all copies, in any form, of the Software in the same form and manner that such copyright and other proprietary notices are included on the Software. Except as expressly authorized, you shall not make any copies or duplicates of any Software without the prior written permission of Iridium.

Term and Termination. The license granted herein shall remain effective until terminated. You may terminate the license at any time by destroying all copies of Software and any Documentation. Your rights under the license will terminate immediately without notice from Iridium if you fail to comply with any provision of the license and Limited Warranty. Upon termination, you shall destroy all copies of Software and Documentation in your possession or control. All of your confidentiality obligations and all limitations of liability and disclaimers and restrictions of warranty shall survive termination.

Export, Re-Export, Transfer and Use Controls. The Software, Documentation and technology or direct products thereof (hereafter

referred to as Software and Technology), supplied by Iridium are subject to export controls under the laws and regulations of the United States (U.S.). You shall comply with such laws and regulations governing export, re-export, transfer and use of Iridium Software and Technology and will obtain all required U.S. and local authorizations, permits, or licenses. Iridium and you each agree to provide the other information, support documents, and assistance as may reasonably be required by the other in connection with securing authorizations or licenses.

U.S. Government End User Purchasers. The Software and Documentation qualify as “commercial items,” as that term is defined at Federal Acquisition Regulation (“FAR”) (48 C.F.R.) 2.101, consisting of “commercial computer software” and “commercial computer software documentation” as such terms are used in FAR 12.212. Consistent with FAR 12.212 and DoD FAR Supp. 227.7202-1 through 227.7202-4, and notwithstanding any other FAR or other contractual clause to the contrary in any agreement into which this Limited Warranty may be incorporated, you may provide to Government end user or Government end user will acquire, as applicable, the Software and Documentation with only those rights set forth in this Limited Warranty. Use of either the Software or Documentation or both constitutes agreement by the Government that the Software and Documentation are “commercial computer software” and “commercial computer software documentation,” and constitutes acceptance of the rights and restrictions herein.

**Important notice for end users in
Australia and New Zealand**

This product comes with guarantees that cannot be excluded under the Australian Consumer Law and similar legislation in New Zealand. Notwithstanding the standard global warranty in the User Manual (which is negated by this notice and will not be applied to limit consumer rights under such guarantees), where such guarantees operate consumers are entitled to a replacement or a refund for a major failure of this product and for compensation for any other reasonably foreseeable loss or damage. Consumers are also entitled to have this product repaired or replaced if the product fails to be of acceptable quality and failure does not amount to a major failure.

Please follow the instructions as to use and report problems promptly: problems caused by use that is abnormal or contrary to instructions will generally not be covered. You should contact your service provider in relation to problems with products and we at Iridium will assist your service provider to resolve them, including by replacement where required.

We are Iridium Satellite LLC,

Toll Free +1.866.947.4348,
Local or International +1.480.752.5155,
Fax +1.480.752.1105,

Iridium Satellite LLC
1800 S. Price Road
Chandler, AZ 85286, USA

and other contact details at www.iridium.com

Your service provider's contact details will appear on the sales documentation.

web: www.iridium.com
email: info@iridium.com
toll free: +1.866.947.4348
phone: +1.480.752.5155
address:
Iridium Satellite LLC
1800 S. Price Road
Chandler, AZ 85286, USA

